

BECKER AVIONICS

Remote Control Unit RCU6512

**for
VHF Transceiver RT6512**

Installation and Operation

Manual DV17551.03

Issue 06 January 2024

Article-No. 0645.230-071

Approved Production and Maintenance Organization

Certificates see: <http://www.becker-avionics.com/certification/> →Certificates

Contact data for:

**Europe, Asia,
Oceania and
Africa** **Becker Avionics GmbH**
Baden-Airpark B108
77836 Rheinmünster (Germany)
Tel.: +49 7229 305-0
Fax: +49 7229 305-217
Internet: www.becker-avionics.com
Email: info@becker-avionics.com

Customer Service:

Email: support@becker-avionics.com

Contact data for:

**America,
Australia, Japan** **Becker Avionics Inc.**
Email: info@beckerusa.com



WARNING - USER RESPONSIBILITY

FAILURE OR IMPROPER SELECTION OR IMPROPER USE OF THE PRODUCTS DESCRIBED HEREIN OR RELATED ITEMS CAN CAUSE DEATH, PERSONAL INJURY AND PROPERTY DAMAGE.

This document and other information from Becker Avionics provide product or system options for further investigation by users having technical knowledge.

The user is responsible for making the final selection of the system and components. The user has to assure that all performance, endurance, maintenance, safety requirements of the application are met and warnings be obeyed.

For this the user has to include all aspects of the application to be compliant with the applicable industry standards and the requirements of the responsible aviation authority. The product documentations from Becker Avionics have to be obeyed.

To the extent that Becker Avionics provide component or system options based upon data or specifications provided by the user, the user is responsible for determining that such data and specifications are suitable and sufficient for all applications and reasonably foreseeable uses of the components or systems.

Term definition: User in the sense of user, installer, installation company.

Preface

Dear Customer,

Thank you for purchasing a Becker Avionics product. We are pleased that you have chosen our product and we are confident that it will meet your expectations.

For development and manufacturing of our product, the guidelines for highest quality and reliability have been borne in mind, supplemented by selection of high-quality material, responsible production and testing in accordance with the standards.

Our competent customer support department will respond on any technical question you may have. Please do not hesitate to contact us at any time.

Remote Control Unit for VHF-Transceiver



Remote Control Unit - RCU6512-(1XX), RCU6512-(2XX)



Remote Control Unit - RCU6512-(3XX)

design depends on variant.

* Some figures in this manual are for basic understanding and can be different to the actual design.

List of Effective Pages and Changes

Only technical relevant modifications are described in this table.

Document:		DV17551.03 issue 06	Article Number 0645.230-071
Cover Page		01/2024	
Introduction		01/2024	
Chapter 1 – 4		01/2024	
Issue	Page No.:	Section / Chapter	Description
06	1-80	all	Changed: Editorial adjustments
	--	all	Added: NVIS variant RCU6512-(2XX)
	--		
	--		
	--		
	--		
	--		
	--		
	--		
	--		
	--		
	--		
	--		
	--		
	--		
	--		

© by Becker Avionics GmbH / all rights reserved

Table of Contents

1	General Description	11
1.1	Introduction	12
1.2	Purpose of Equipment.....	13
1.3	Variants Overview	14
1.3.1	Software Status.....	14
1.4	Associated Devices	14
1.4.1	Overview	15
1.5	Scope of Functionality.....	16
1.5.1	Panel Backlight	16
1.5.2	Channel Spacing / Frequency Range.....	16
1.5.3	Memory Channels / Frequency Storage	17
1.5.4	Squelch Operation	17
1.5.5	Sidetone.....	17
1.5.6	Emergency Operation	17
1.5.7	Configuration Mode.....	17
1.5.8	Installation Mode.....	17
1.5.9	Interface	17
1.5.10	Tandem Operation	18
1.5.11	Built-In Tests (BIT)	18
1.6	Cleaning and Disinfection of Device	19
1.7	Safety-Conscious Utilization	20
1.8	Restriction for Use.....	20
1.9	Technical Data	21
1.9.1	General Characteristics	21
1.9.2	Dimensions & Weight.....	21
1.9.3	Software.....	21
1.9.4	Hardware	21
1.9.5	Continued Airworthiness	21
1.9.6	Environmental Conditions	22
1.9.7	Certifications	23
1.10	Order Code	24
1.10.1	RCU6512	24
1.10.2	Accessories.....	24
1.10.3	Documentation.....	24
2	Installation.....	25
2.1	Packaging, Transport, Storage	26
2.2	Device Assignment	27
2.2.1	Scope of Delivery.....	27
2.2.2	State of Delivery.....	27
2.2.3	Additional Equipment	27
2.2.4	Type Plate.....	28
2.2.5	Software/Firmware Status – Functionality	28
2.3	Installation Requirements.....	29
2.3.1	Rear Panel Installation.....	30
2.3.2	Audio Volume Interface - Connector Wiring (RCU6512-(3XX) only).....	31
2.4	Dimensions	33
2.4.1	RCU6512-(1XX), RCU6512-(2XX)	33
2.4.2	RCU6512-(3XX).....	34
2.5	Connector Pin Assignments.....	35
2.5.1	RCU6512-(1XX), RCU6512-(2XX)	35
2.5.2	RCU6512-(1XX), RCU6512-(2XX) - Connector P1	35
2.5.3	RCU6512 -(3XX).....	36
2.5.4	RCU6512-(3XX) - Connector P1	37
2.5.5	RCU6512-(3XX) - Connector J1 (Audio Connector).....	37
2.5.6	Discrete In-/Outputs	38
2.5.7	Panel Backlight	38
2.5.8	External Power ON (/EXT_ON)	39
2.5.9	External Exchange (/EXCH_CH)	39
2.5.10	Selection Pin	39
2.6	Equipment Configuration Samples	40
2.6.1	RCU6512 with RT6512.....	40

2.6.2	RCU6512-(3XX) Tandem Operation with RT6512	40
2.6.3	RCU6512-(3XX) – External Channel Data Base Configuration	41
2.7	Aircraft Wiring	42
2.7.1	Installation Switch (INS_SW)	42
2.7.2	Electrical Bonding and Grounding - RCU6512-(3XX)	42
2.7.3	Wiring - RCU6512-(1XX), RCU6512-(2XX) as Primary Controller with RT6512	43
2.7.4	RCU6512-(3XX) for Tandem Operation with RT6512	44
2.8	Configuration-Setup	46
2.8.1	Installation Mode (INS MODE)	46
2.8.2	Configuration Mode (CFG MODE)	53
2.9	Factory Default Settings	58
2.9.1	RCU6512-(1XX), RCU6512 (2XX)	58
2.9.2	RCU6512-(3XX)	58
2.10	Post Installation Check	59
2.10.1	Mechanical Installation and Wiring Check	59
2.10.2	Power Supply	59
2.10.3	Receiver / Transmitter Operation	59
2.10.4	Flight Test Check	59
2.11	Troubleshooting	59
3	Operation	61
3.1	General	61
3.2	Device Description	62
3.2.1	Available Channel / Frequency Memory	62
3.2.2	Device Assignment	63
3.2.3	Packing, Transport, Storage	63
3.2.4	Scope of Delivery	63
3.2.5	State of Delivery	63
3.2.6	Type Plate	63
3.2.7	Controls and Indications	64
3.3	Start-Up	65
3.4	Receive and Transmit Mode	66
3.4.1	Receive Mode	66
3.4.2	Transmit Mode	66
3.5	Frequency Selection Modes	67
3.5.1	Standard Mode	68
3.5.2	Direct Tune Mode	69
3.5.3	Channel Mode	70
3.6	Frequency Storage Functions	71
3.6.1	Store "Active Frequency"	72
3.6.2	Automatic Storage Function (LAST)	73
3.6.3	Store "Preset Frequency"	74
3.6.4	Channel Memory Erase	75
3.7	Squelch (SQL)	76
3.7.1	Squelch Threshold	76
3.8	Channel Spacing	76
3.9	Brightness	76
3.10	Warning and Failure Indications	77
3.11	Contact Data	79
4	Index	80

List of Figures

Some figures in this manual are for basic understanding and can be different to the actual design.

Figure 1: Application - RCU6512 + RT6512 + Antenna (example)	15
Figure 2: Tandem Application - 2x RCU6512-(3XX) + RT6512 + Antenna (example)	15
Figure 3: RCU6512-(1XX), RCU6512-(2XX).....	16
Figure 4: RCU6512-(3XX).....	16
Figure 5: Type plate (example)	28
Figure 6: Dimensions RCU6512 (front view).....	30
Figure 7: Drilling template (rear panel mounting)	30
Figure 8: Dimensions - Cable Connector J1	31
Figure 9: Exploded View - Cable Connector J1	31
Figure 10: Cable Assembly - Cable&Connector J1	32
Figure 11: Dimensions - RCU6512-(1XX), RCU6512-(2XX)	33
Figure 12: Dimensions - RCU6512-(3XX)	34
Figure 13: RCU6512-(1XX), RCU6512-(2XX) - Connector Layout	35
Figure 14: RCU6512-(3XX) - Connector Layout	36
Figure 15: RCU6512 with RT6512	40
Figure 16: RCU6512 Tandem Operation with RT6512	40
Figure 17: RCU6512 (3XX) – External Channel Data Base Configuration.....	41
Figure 18: Wiring - RCU6512-(1XX), RCU6512-(2XX) as Primary Controller with RT6512.....	43
Figure 19: Wiring - Two RCU6512 (3XX) for Tandem Operation with RT6512.....	45
Figure 20: "CFG MODE"	47
Figure 21: "INS MODE"	47
Figure 22: "PASSWORD 0000"	47
Figure 23: "PASSWORD"	47
Figure 24: "CU CONTRAST"	48
Figure 25: "CU DIMMING_IN"	48
Figure 26: "CU TANDEM_EN"	48
Figure 27: "CU MEMORY"	49
Figure 28: "CU ERASE_MEM".....	49
Figure 29: "CU ERASE_MEM".....	49
Figure 30: "RT CONFIG"	50
Figure 31: "RT MOD_LIMIT"	51
Figure 32: "RT SERVICE".....	52
Figure 33: "CFG MODE"	53
Figure 34: "CU DEV_INFO"	53
Figure 35: "CU BRIGHTNESS"	54
Figure 36: "CU ILLUM"	54
Figure 37: "CU ILLUM"	55
Figure 38: "CU SPACING"	55
Figure 39: "RT DEV_INFO".....	56
Figure 40: "RT SQL_LEVEL"	56
Figure 41: "RT SIDE_LEVEL"	56
Figure 42: "RT TIME"	57
Figure 43: "RT TEMP"	57
Figure 44: "RT ERR_LATCH".....	57
Figure 45: RCU6512 - Controls and Indications	64

List of Abbreviations

List of Abbreviations

AF	Audio Frequency
ATT	Attenuation
AUX	Auxiliary
AWG	American Wire Gauge
CBIT	Continuous Built-In Test
CFG	Configuration
CH, ch	Channel, Memory Channel
COM	Communication
EASA	European Aviation Safety Agency
EMI	Electro Magnetic Interference
ETSO	European Technical Standard Order
EUROCAE	European Organization for Civil Aviation Equipment
FAA	Federal Aviation Administration
GND	Ground (Aircraft Ground)
GPS	Global Positioning System
HIRF	High Intensity Radiated Fields
HMI	Human Machine Interface
IC	Intercom
IBIT	Initiated Built-In Test
LCD	Liquid Crystal Display
N/A	Not Applicable
NVIS	Night Vision
PBIT	Power-On Built-In Test
PTT	Push-To-Talk
PWR	Power
RCU	Remote Control Unit
RT	Remote Transceiver
RX	Receive
SQL	Squelch
SRC	Source
SW	Software
tbd	to be defined
TSO	Technical Standard Order
TF	TufLok®, self-locking screws and threads
TX	Transmit
VDC	Voltage Direct Current
VHF	Very High Frequency
VSWR	Voltage Standing Wave Ratio

Units

Units	
A, mA	Ampere, Milliampere
°C	Degree Celsius
cm, mm	Centimeter, Millimeter
dBm	Power Ratio in Decibel referenced to 1 mW
dB	Decibel
g, kg	Gram, Kilogram
kHz, MHz	Kilohertz, Megahertz
Nm	Newton Meter
NM	Nautical Mile (1 NM = 1852 m)
Ω , m Ω	Resistance in Ohm, Milliohm
s	Second
V, mV	Volt, Millivolt
W, mW	Watt, Milliwatt
"	Inch
°	Angular degree

General Safety Definitions



Indicates a hazardous situation which, if not prevented, will result in death or serious injury.



Indicates a hazardous situation which, if not prevented, could result in death or serious injury.



Indicates a hazardous situation which, if not prevented, could result in minor or moderate injury.



Is used to address practices not related to physical injury.



Safety instructions (or equivalent) signs indicate specified safety-related instructions or procedures.

Disposal

⚠CAUTION The packaging material is inflammable, by burning toxic fumes may develop.

This product contains materials that fall under the special disposal regulation. We recommend the disposal of such materials in accordance with the current environmental laws.

- Dispose circuit boards by a technical waste dump which is approved to take on e.g. electrolytic aluminum capacitors. Do under no circumstances dump the circuit boards with normal waste dump.

Warranty Conditions

⚠CAUTION The device(s) may be installed on an aircraft only by an approved aeronautical company (e.g. Part 145) which shall also examine the installation.

Any change made by the user excludes any liability on our part (excluding the work described in this manual).

- The device must not be opened.
- Do not make any modifications to the device, except for those described in the manual.
- Make connections to the inputs, outputs and interfaces only in the manner described in the manual.
- Install the devices according to the instructions.
We cannot give any guarantee for other methods.

Conditions of Utilization

With this device you bought a product which was manufactured and tested before delivery with the utmost care.

Please take your time to read the instructions which you ought to follow closely during installation and operation.

Otherwise all claims under the warranty will become void and a decreased service life or even damages must be expected.

⚠CAUTION The user is responsible for protective covers and/or additional safety measures in order to prevent damages to persons and electric accidents.

Additional Conditions of Utilization

Please refer to "Safety-Conscious Utilization", page 20.

Non-Warranty Clause

We checked the contents of this publication for compliance with the associated hard and software. We can, however, not exclude discrepancies and do therefore not accept any liability for the exact compliance. The information in this publication is regularly checked, necessary corrections will be part of the subsequent publications.

1 General Description

In this chapter you can read about:

1.1	Introduction	12
1.2	Purpose of Equipment.....	13
1.3	Variants Overview	14
1.3.1	Software Status.....	14
1.4	Associated Devices.....	14
1.4.1	Overview	15
1.5	Scope of Functionality.....	16
1.5.1	Panel Backlight	16
1.5.2	Channel Spacing / Frequency Range.....	16
1.5.3	Memory Channels / Frequency Storage	17
1.5.4	Squelch Operation	17
1.5.5	Sidetone.....	17
1.5.6	Emergency Operation	17
1.5.7	Configuration Mode.....	17
1.5.8	Installation Mode.....	17
1.5.9	Interface	17
1.5.10	Tandem Operation	18
1.5.11	Built-In Tests (BIT)	18
1.6	Cleaning and Disinfection of Device	19
1.7	Safety-Conscious Utilization	20
1.8	Restriction for Use.....	20
1.9	Technical Data	21
1.9.1	General Characteristics	21
1.9.2	Dimensions & Weight.....	21
1.9.3	Software.....	21
1.9.4	Hardware	21
1.9.5	Continued Airworthiness.....	21
1.9.6	Environmental Conditions.....	22
1.9.7	Certifications	23
1.10	Order Code	24
1.10.1	RCU6512	24
1.10.2	Accessories.....	24
1.10.3	Documentation.....	24

This manual describes the Becker Avionics Remote Control Unit RCU6512 and its variants. The type plate on your device shows the part number for identification purposes (see "Type Plate", page 28).

Before starting operation of the device(s) please read this manual carefully, with particular attention to the description referring to your device(s).

Introduction

1.1 Introduction

The technical information in this document applies to the described product and variants of RCU6512-(XXX).

- We also use the term RCU6512, RCU for descriptions instead of writing the complete model number.
- If a description refers to only one product variant it is specified.

The manuals "Maintenance and Repair" (**M&R**), "Installation and Operation (**I&O**) contain the sections:

Section	DV17551.04 M&R	DV17551.03 I&O
General	X	X
Installation	X	X
Operation	X	X
Theory of Operation	X	N/A
Maintenance and Repair	X	N/A
Illustrated Parts List	X	N/A
Modification and Changes	X	N/A
Circuit Diagrams	X	N/A
Certifications	X	N/A
Attachments	X	N/A

1.2 Purpose of Equipment

The Becker Avionics Remote Control Unit RCU6512 is made to operate with the VHF transceivers of the RT6512 series.

The primary function of RCU6512 is to be the HMI (Human Machine Interface) for interaction between users and VHF transceiver.

- The system of RCU6512 and transceiver is for voice communication between aircraft or between an aircraft and ground stations, using the very high frequency band between 118.000...155.975 MHz (depends on RT6512 variant).
- The RCU6512 is made for installation in the instrument panel of an aircraft.
 - The dimensions correspond to the standard for instruments 58 mm (2¼ inch).
- Installation with standard supply 28 VDC or with 24 VDC batteries possible.
- The RCU6512 can operate at emergency voltage 18 V without any degradation of performance.
- Channel spacing of 25 kHz or 8.33 kHz.
- Non-volatile memory for storing up to 40 or 99+9 frequencies/channels (depends on variant).
- Squelch functionality, ON/OFF for squelch function of controlled transceiver.
- Data exchange between RCU6512 and VHF transceiver through a RS422 serial interface.
- Different built-in tests examine the correct operation of RCU6512 and transceiver.
- Tandem function for a synchronized operation of two controllers in the same installation (depends on RCU variant).
 - Support for 2-way intercom for tandem operation – pilot and co-pilot have different controllers and can control their individual audio parameters, like volume or VOX.
 - In tandem installations, RCU6512-(3XX) has independent volume control for each audio output.
 - Preferred application for training due to full synchronization of LCD contents.

1.3 Variants Overview

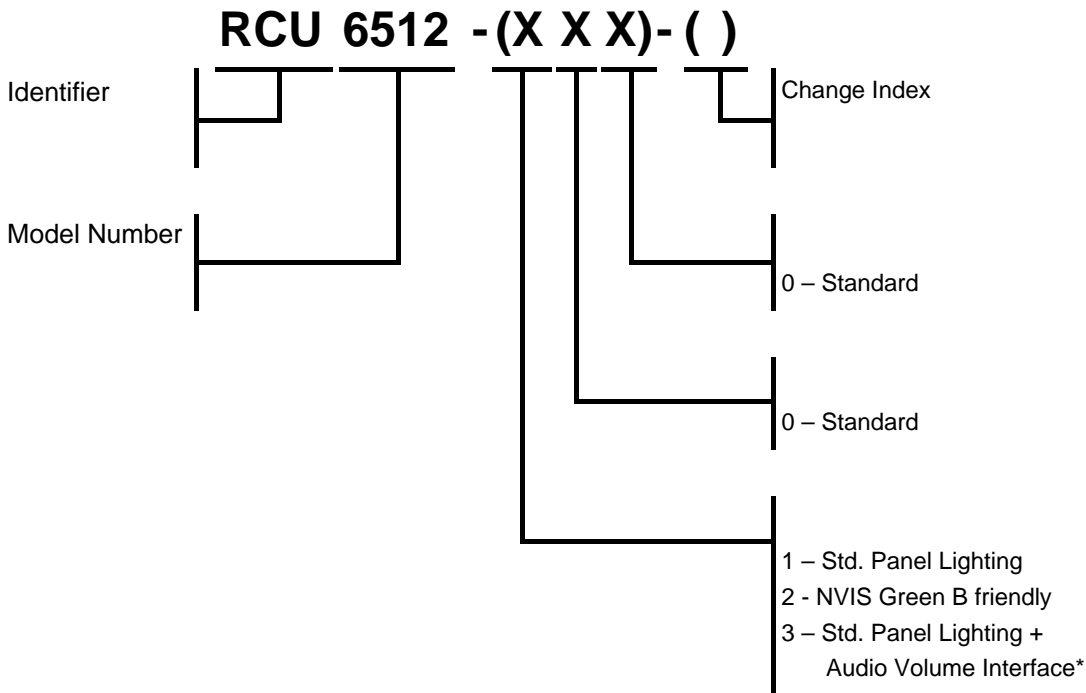

Notice:

* Variant for tandem installation

1.3.1 Software Status

Descriptions see "Software/Firmware Status – Functionality", page 28.

1.4 Associated Devices

These devices can operate with RCU6512:

Device	Function
RT6512	Becker Avionics Remote-Controlled VHF Transceiver

This manual describes the RCU6512 from Becker Avionics. For other devices please refer to the related manuals.

1.4.1 Overview



Figure 1: Application - RCU6512 + RT6512 + Antenna (example)



Figure 2: Tandem Application - 2x RCU6512-(3XX) + RT6512 + Antenna (example)

1.5 Scope of Functionality

- The RCU6512 is a compact and lightweight device.
- All controls and indicators are on the front panel.
- The equipment connectors are at the rear side of the device.
- Installation with four screws (rear panel installation).
The dimensions correspond to the standard instrument diameter of 58 mm (2¼ inch).



Figure 3: RCU6512-(1XX), RCU6512-(2XX)



Figure 4: RCU6512-(3XX)

1.5.1 Panel Backlight

The backlight of the LCD and push buttons can be controlled.

- Direct control from the front panel (through the user menu).
- External control through the dimming input lines.
 - With external dimming application the dimming curve (voltage to brightness relation) is adjustable in the configuration setup.

RCU6512-(2XX): NVIS Green B friendly

- This variant works in combination with night vision goggles.
- It complies with MIL-STD-3003 in relation to the NVIS Green B radiance and colorimetric standard.
- The dimming characteristic must be adjusted to the given cockpit lighting.
- The standard Becker Avionics NVIS dimming curve is used.

1.5.2 Channel Spacing / Frequency Range

The RCU6512 together with RT6512 is for voice communication between aircraft or between an aircraft and ground stations using the VHF band between 118.000...155.975 MHz (depends on RT6512 variant).

- 8.33 kHz channel spacing: from 118.000...136.990 MHz.
- 25 kHz channel spacing: from 118.000...136.975 MHz.
- 25 kHz channel spacing in extended frequency from: 118.000...155.975 MHz.
- The RCU6512 operates with all frequency band variants of RT6512 transceiver series.

1.5.3 Memory Channels / Frequency Storage

RCU6512-(3XX):

- The RCU6512-(3XX) can store 99+9 frequencies assigned to channel numbers in two channel memories.
 - 99 channels reserved for the channel spacing modes 8.33/25 kHz in the user channel memory.
 - The last recently used 9 (active) frequencies are stored as "LAST" channels in the LAST channel memory.

Other variants:

- The RCU6512 can store up to 40 frequencies assigned to channel numbers in two user channel memories.
 - 20 channels reserved for 25 kHz channels spacing mode.
 - 20 channels reserved for 8.33/25 kHz channel spacing mode.

NOTICE

The word "frequency" is also used in the sense of "channel name", as defined in ICAO Annex 10, Volume 5, chapter 4.1.2.

In this document the word "memory channel" or "channel" means a memory place identified by a channel number, where a frequency can be stored for later use.

1.5.4 Squelch Operation

- The squelch (muting) circuit suppresses unwanted audio noise.
- RCU6512 can change between ON/OFF for squelch function of controlled transceiver.
- Squelch threshold is adjustable through the configuration mode.

1.5.5 Sidetone

- The sidetone level is available on the line output of controlled transceiver during transmission.
- The sidetone level is adjustable through the configuration mode.

1.5.6 Emergency Operation

- If the power supply voltage falls below 18 V, the RT6512 stops operating.
- If the power supply falls below 9.0 V, the RCU6512 device automatically powers off.

1.5.7 Configuration Mode

- Configuration of diverse parameters is made in the "Configuration Mode".

1.5.8 Installation Mode

- This mode is password-protected and for use by authorized maintenance organizations during aircraft service on ground only.

1.5.9 Interface

- The RCU6512 uses the RS422 interface for communication with the transceiver.
- Serial asynchronous data is sent and received through the RS422 interface.

1.5.10 Tandem Operation

Tandem operation is especially required for aircrafts with front and rear seats configuration, which is typical for training aircrafts or gliders.

- The tandem mode is for operation of two controllers in an installation at the same time.
- In tandem mode the operation and view are synchronized, both RCU6512-(3XX) show the same information.
- The data exchanged between the two RCU6512-(3XX) is done over RS422 interface.

NOTICE

Configuration with two controllers for tandem operation is only possible with RCU6512-(3XX) and RT6512.

1.5.11 Built-In Tests (BIT)

The RCU6512 has advanced Built-In-Tests. It monitors most internal circuits against failures. The Built-In Tests (BIT) monitors some external (installation) conditions to increase the reliability of RCU6512 and RT6512.

Types of BIT:

- Power-On Built-In Test (PBIT)
starts after Power ON the RCU6512 and RT6512 system.
- Initiated Built-In Test (IBIT),
on-request test of remote transceiver initiated by special command through push buttons.
- Continuous Built-In Test (CBIT)
which continuously examines controller and transceiver operation.

1.6 Cleaning and Disinfection of Device

Cleaning:

Within the framework of officially prescribed or recommended protective measures, it makes sense that devices and systems that are directly accessible to people, are disinfected as required. This particularly applies to the controls on devices.

NOTICE

Not all commercially available cleaning agents/disinfectants are suitable for use on the surfaces of the devices. Many of the agents contain solvents or greasing components that can cause undesired effects on the controls and the display.

Example:

- Do not use aggressive cleaning agents e.g. Acetone.
 - These cleaning agents can cause damages.

Procedure:

NOTICE

- Do not clean/disinfect the device(s) during operation.

Device body and the controls:

- Clean the device body and the controls with a clean, soft, lint free cloth moistened with clean water.

Disinfection:

To reduce the risk of infection:

- As a disinfectant, we recommend diluted monohydric alcohols such as Isopropanol or Ethanol.
 - Wear suitable protective gloves that are disinfected.
 - Moisten a clean, soft, lint free cloth with the related liquid to clean all controls.
 - Please obey the usual protective measures when using monohydric alcohols for cleaning purposes.
- Do not use spray bottles or evaporators to apply disinfectants or cleaning liquids to the Becker Avionics devices. Liquids can penetrate the devices and can result in damage.

LCD screen:

- Clean LCD screens with a clean, soft, lint free cloth moistened with clean water and take care not to scratch the surface.
- Cleaning agents suitable for cleaning TFT screens and LCD displays can also be used. Obey the related instructions from manufacturer.

1.7 Safety-Conscious Utilization

⚠ CAUTION The device(s) may be installed on an aircraft only by an approved aeronautical company (e.g. Part 145) which shall also examine the installation.

SAFETY INSTRUCTIONS

- The installation of the device into an aircraft may be carried out only by an authorized installation company. The country regulations must always be obeyed.
- Use the product only in the specified conditions, see "Technical Data", page 21.
- Power supply:
 - Do not connect the device to AC sources.
 - Make sure that the device is connected to the mandatory DC source, see "Technical Data", page 21.
 - Do not connect the device with reversed polarity to the DC source.
- Circuit breaker:
 - Use the recommended fuses in the power supply line for protection of the application, see "Aircraft Wiring", page 42.

NOTICE

Cleaning:

- Do not use aggressive cleaning agents e.g. Acetone.
 - These cleaning agents can cause damages.

NOTICE

Excessive pulses on the DC bus of the aircraft can damage the electrical circuits of any installed instrument.

Do not power-on the device during engine start or shutdown.

1.8 Restriction for Use

SAFETY INSTRUCTIONS

The product is to be used inside the declared limits.

1.9 Technical Data

1.9.1 General Characteristics

RCU6512	
Nominal supply voltage	14...28 VDC
Extended supply voltage	9.0...32.2 VDC
Emergency operation voltage (with RT6512)	18...20.5 VDC
Maximum Power Consumption	≤ 90 mA
Turn OFF Power Consumption	≤ 1 mA
Frequency Range	118.000...155.975 MHz (depends on RT6512 variant)
Channel Spacing	25 kHz 8.33/25 kHz (up to 136.9916 MHz)
Device protection (internal fuse)	1 A
Dimming control	0...5 V, 0...14 V or 0...28 V
Storage temperature range	-55...+85 °C
Operating temperature range	-20...+55 °C, short-time +70 °C
Operating altitude	35 000 ft

1.9.2 Dimensions & Weight

RCU6512	Specifications	
	RCU6512-(1XX), RCU6512-(2XX)	RCU6512-(3XX)
Dimensions HxW	61.2 x 61.2 mm (2.4 x 2.4 inch)	
Depth of device	65.9 mm (2.59 inch)	72 mm (2.83 inch)
Mounting depth	39.3 mm (1.55 inch)	41mm (1.61 inch)
Weight	≤ 0.2 kg (0.44 lbs)	≤ 0.2 kg (0.44 lbs)
Material	AlMg/Plastic	
Panel color	Control-head coated black matt	

1.9.3 Software

In accordance with EUROCAE/RTCA Document ED-12C/DO-178C the software is specified as:

Design Assurance Level (DAL) "C"

1.9.4 Hardware

The RCU6512 devices do not contain Complex Electronic Hardware (CEH).

1.9.5 Continued Airworthiness

- The RCU6512 maintenance is defined as "on condition" only.
- No scheduled or regular maintenance of this product is required.

Technical Data

1.9.6 Environmental Conditions

The tests were done in accordance with EUROCAE/RTCA Document ED-14G/DO-160G under consideration of the recorded environmental categories and conditions:

Environmental Condition	Section	Cat.	Remarks
Temperature and Altitude	4	C4	--
Ground Survival Low Temperature	4.5.1	C4	-55 °C
Low Operating Temperature	4.5.2	C4	-20 °C
High Ground Survival Temperature	4.5.3	C4	+85 °C
High Short-Time Operating Temperature	4.5.3	C4	+70 °C
High Operating Temperature	4.5.4	C4	+55 °C
In-flight Loss of Cooling	4.5.5	Z	No forced cooling required
Altitude	4.6.1	C4	35 000 ft
Decompression	4.6.2	X	no test done
Overpressure	4.6.3	X	no test done
Temperature Variation	5.0	B	5 °C per minute
Humidity	6	A	Standard
Operational Shock and Crash Safety	7.2 7.3	B	--
Vibration	8	S U	Category S - Curve M Category U - Curve G
Explosion Atmosphere	9	X	no test done
Water Proofness	10	X	no test done
Fluids Susceptibility	11	X	no test done
Sand and Dust	12	X	no test done
Fungus Resistance	13	X	no test done
Salt Fog	14	X	no test done
Magnetic Effect	15	Z	1° deflection at < 0.3 m
Power Input	16	B(XX)	--
Voltage Spike	17	A	--
Audio Freq. Conducted Susceptibility	18	B	--
Induced Signal Susceptibility	19	ACX	--
Radio Frequency Susceptibility	20	SW	--
Emission of Radio Frequency Energy	21	B	--
Lightning Induced Transients Susceptibility	22	A1 E3 XX	Pin Test: Waveform A, Level 1 Cable Bundle Test: Waveform E, Level 3
Lightning Direct Effects	23	X	no test done
Icing	24	X	no test done
Electrostatic Discharge	25	A	--
Fire, Flammability	26	X	no test done

1.9.7 Certifications

RCU6512 certification:

Number	Description
EASA.21O.10062248	In accordance with Commission Regulation (EU) No. 748/2012, Part 21, Section A, Subpart O and ETSO-2C169a.

RCU6512 meets the requirements of:

Number	Description
ETSO-2C169a	VHF Radio Communications Transceiver Equipment Operating within Radio Frequency Range 117.975 to 137.000 MHz.
TSO-C169a	VHF Radio Communications Transceiver Equipment Operating within Radio Frequency Range 117.975 to 137.000 MHz.

Considered EUROCAE documents:

Number	Description
EUROCAE ED-23C	MOPS for Airborne VHF Receiver-Transmitter Operating in the Frequency Range 117.975 - 137.000 MHz.
EUROCAE ED-12C	Software Considerations in Airborne Systems and Equipment Certification.
EUROCAE ED-14G	Supporting Information for ED-12C and ED-109A.

NOTICE

The RCU6512 does not influence the receiver and transmitter performance data (despite the used channel frequency). By this, corresponding tests were not done for qualification of RCU6512.

Order Code

1.10 Order Code**1.10.1 RCU6512**

Qty	Device	
1	RCU6512-(100)-(), Remote Control Unit, Standard Panel Lighting	Article-No. 0637.297-910
1	RCU6512-(300)-(), Remote Control Unit, Standard Panel Lighting with Audio Volume Interface	Article-No. 0678.120-910
1	RCU6512-(200)-(), Remote Control Unit, NVIS Panel Lighting	Article-No. 0683.027-910

1.10.2 Accessories

Qty		
1	CK5000-S: Connector Kit (soldering version): <ul style="list-style-type: none"> D-Sub15-s, Connector housing, Label "COMM", Label "NAV", Label "ADF", Label "XPDR" 	Article-No. 0511.791-954
1	CK5000-C: Connector Kit (crimp version): <ul style="list-style-type: none"> D-Sub15- c, Connector housing, Label "COMM", Label "NAV", Label "ADF", Label "XPDR" 	Article-No. 0511.781-954
1	CK5012-S: Connector Kit (soldering version): <ul style="list-style-type: none"> Circular connector, 5pin, male 	Article-No. 0678.538-954

1.10.3 Documentation

Qty	Documentation	
1	(I&O) RCU6512 Installation and Operation manual, English	Article-No. 0645.230-071
1	(M&R) RCU6512 Maintenance and Repair manual, English	Article-No. 0645.249-071

2 Installation

This manual must be available during performance of all tasks.

The installation of the device(s) depends on the type of aircraft and its equipment and therefore only general information can be given in this section.

Any deviations from the instructions in this document are under own responsibility.

In this chapter you can read about:

2.1	Packaging, Transport, Storage	26
2.2	Device Assignment	27
2.2.1	Scope of Delivery	27
2.2.2	State of Delivery.....	27
2.2.3	Additional Equipment.....	27
2.2.4	Type Plate.....	28
2.2.5	Software/Firmware Status – Functionality	28
2.3	Installation Requirements.....	29
2.3.1	Rear Panel Installation.....	30
2.3.2	Audio Volume Interface - Connector Wiring (RCU6512-(3XX) only).....	31
2.3.2.1	Cable&Connector J1	31
2.3.2.2	Requirements - Cable&Connector J1.....	31
2.4	Dimensions	33
2.4.1	RCU6512-(1XX), RCU6512-(2XX)	33
2.4.2	RCU6512-(3XX).....	34
2.5	Connector Pin Assignments.....	35
2.5.1	RCU6512-(1XX), RCU6512-(2XX)	35
2.5.2	RCU6512-(1XX), RCU6512-(2XX) - Connector P1	35
2.5.3	RCU6512 -(3XX).....	36
2.5.4	RCU6512-(3XX) - Connector P1	37
2.5.5	RCU6512-(3XX) - Connector J1 (Audio Connector).....	37
2.5.6	Discrete In-/Outputs	38
2.5.7	Panel Backlight	38
2.5.7.1	RCU6512-(1XX), RCU6512-(2XX)	38
2.5.7.2	RCU6512-(3XX)	38
2.5.8	External Power ON (/EXT_ON)	39
2.5.9	External Exchange (/EXCH_CH)	39
2.5.10	Selection Pin	39
2.5.10.1	RCU6512-(1XX), RCU6512-(2XX)	39
2.5.10.2	RCU6512-(3XX)	39
2.6	Equipment Configuration Samples	40
2.6.1	RCU6512 with RT6512.....	40
2.6.2	RCU6512-(3XX) Tandem Operation with RT6512	40
2.6.3	RCU6512-(3XX) – External Channel Data Base Configuration	41
2.7	Aircraft Wiring.....	42
2.7.1	Installation Switch (INS_SW).....	42
2.7.2	Electrical Bonding and Grounding - RCU6512-(3XX).....	42
2.7.3	Wiring - RCU6512-(1XX), RCU6512-(2XX) as Primary Controller with RT6512	43
2.7.4	RCU6512-(3XX) for Tandem Operation with RT6512.....	44
2.7.4.1	Configuration - Two RCU6512-(3XX) for Tandem Operation with RT6512	44
2.7.4.2	Wiring -Two RCU6512-(3XX) for Tandem Operation with RT6512	45
2.8	Configuration-Setup	46
2.8.1	Installation Mode (INS MODE)	46
2.8.1.1	Start Installation Mode.....	47
2.8.1.2	RCU - Password.....	47
2.8.1.3	RCU - Contrast, Dimming Input.....	48
2.8.1.4	RCU - Tandem	48
2.8.1.5	RCU - Memory.....	49
2.8.1.6	RT – Parameters – General (INS MODE)	49
2.8.1.7	RT - Volume, Squelch, Sidetone	50
2.8.1.8	RT - Audio Input Sensitivity (RT MOD_LIMIT)	51
2.8.1.9	RT - Service.....	52
2.8.2	Configuration Mode (CFG MODE).....	53
2.8.2.1	Navigate between Pages.....	53
2.8.2.2	Cancel Configuration Mode.....	53

Packaging, Transport, Storage

2.8.2.3	Start Configuration Mode.....	53
2.8.2.4	RCU - Device Info.....	53
2.8.2.5	RCU - Brightness.....	54
2.8.2.6	RCU6512-(1XX), RCU6512-(2XX) - Dimming.....	54
2.8.2.7	RCU6512-(3XX) - Dimming.....	55
2.8.2.8	RCU - Channel Spacing.....	55
2.8.2.9	RT – Parameters – General (CFG MODE).....	56
2.8.2.10	RT - Device Info.....	56
2.8.2.11	RT - Squelch Threshold (RT SQL_LEVEL).....	56
2.8.2.12	RT - Sidetone Attenuation (RT SIDE_LEVEL).....	56
2.8.2.13	RT - Operating Time (RT TIME).....	57
2.8.2.14	RT - Temperature (RT TEMP).....	57
2.8.2.15	RT - Failure History (RT ERR_LATCH).....	57
2.9	Factory Default Settings.....	58
2.9.1	RCU6512-(1XX), RCU6512 (2XX).....	58
2.9.2	RCU6512-(3XX).....	58
2.10	Post Installation Check.....	59
2.10.1	Mechanical Installation and Wiring Check.....	59
2.10.2	Power Supply.....	59
2.10.3	Receiver / Transmitter Operation.....	59
2.10.3.1	Tandem Installation.....	59
2.10.4	Flight Test Check.....	59
2.11	Troubleshooting.....	59

2.1 Packaging, Transport, Storage

Visually inspect the package contents for signs of transport damage.

⚠ CAUTION The packaging material is inflammable, if it is disposed of improperly by burning, toxic fumes may develop.

Keep the packaging material and use it in the case of a return shipment. Improper or faulty packaging may lead to transport damages.

Make sure to transport the device always in a safe manner and with the aid of applicable lifting equipment if necessary. Do never use the electric connections for lifting. Before the transport, a clean, level surface should be prepared to put the device on. The electric connections may not be damaged when placing the device.

First Device Checkup

- Do a check for signs of damages.
- Please make sure that the indications on the type plate agree with your purchase order.
- Make sure that the equipment is complete ("Scope of Delivery", page 27).

Storage

If you do not install the device immediately, make sure to store it in a dry and clean environment. Make sure that the device is not stored near strong heat sources and that no metal chippings can get into the device.

2.2 Device Assignment

This manual is valid for the devices:

- RCU6512-(1XX)-(), Software Version SCI1038S305 Version 14
- RCU6512-(2XX)-(), Software Version SCI1038S305 Version 14
- RCU6512-(3XX)-(), Software Version SCI1038S305 Version 20 and up

2.2.1 Scope of Delivery

- Manual
 - Installation & Operation
- Device as ordered
- Authorized Release Certificate (EASA Form 1)

2.2.2 State of Delivery

- The RCU6512 is ready for use.
 - No programming procedures required.
 - Default settings see "Factory Default Settings" page 58.

2.2.3 Additional Equipment

- Connectors + cables

Details see "Accessories", page 24.

Device Assignment

2.2.4 Type Plate

The device type is specified by the type plate (on the housing):

Example:

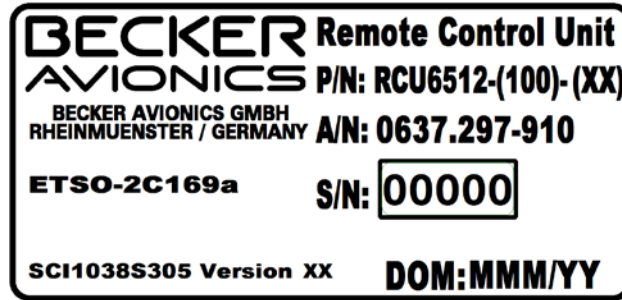

Figure 5: Type plate (example)

Explanation:

P/N:	<p>Type designation: RCU6512 = Remote Control Unit 58 mm (2¼ inch)</p> <p>Options: -(100): Standard Panel Lighting -(200): NVIS Panel Lighting -(300): Standard Panel Lighting with Audio Volume Interface (for tandem operation)</p> <p>Change Index: -(XX): Change index (00...99)</p>
S/N:	Unique number of the particular device
A/N:	Article number
DoM:	Date of Manufacturing
	<p>Software: Refer to the version on the device type plate</p>
	<p>Compliance and Certifications: Refer to the text and logos on the device type plate</p>

2.2.5 Software/Firmware Status – Functionality

- The check of the firmware version is possible in the display through configuration menu.
- The software versions are subject to change without notice.

2.3 Installation Requirements

The installation of the device(s) depends on the type of aircraft and its equipment and therefore only general information can be given in this section.

For connection this equipment is required as minimum for RCU6512 controller:

- Power supply.
- VHF transceiver RT6512 and PTT switch, antenna, microphone, headphone.
- Connectors + cables.

SAFETY INSTRUCTIONS

The installation of RCU6512 into an aircraft may be carried out by an authorized installation company. The country regulations always have to be obeyed.

- The device must not be opened.
- Keep enough distance to devices with integrated ventilator fans to make sure the free circulation of the cooling air.
- The installation area must have a minimum distance of 30 cm from the magnetic aircraft compass, to prevent any interference to the magnetic compass.
- Forced cooling is not required.

SAFETY INSTRUCTIONS

RCU6512 is made for installation in cockpit environment of fixed and rotary wing aircraft.

These limitations apply for the installation:

- The installation must be in accordance with the local aviation authority approved guidelines (e.g. EASA, FAA).
- The personnel installing this device must make sure that the aircraft installation conditions are in the ETSO/TSO standards applicable for the specified type or class of aircraft.
- The conditions and tests for ETSO/TSO approval of this article are minimum performance standards.
- The equipment is not qualified for installation in areas with fluid contamination.
- Changes or modifications made to this equipment not expressly approved in written form by Becker may void the authorization to operate this equipment.

SAFETY INSTRUCTIONS

- Use only cables which are qualified for aircraft use (self-extinguishing).
- Use AWG 20 for power supply and AWG 22/24 for other cables.
- Fit sleeves over the solder joints on the equipment connector.
- Crimp connectors are also available from Becker.
- Use the applicable fuses in the power supply line for the protection of the application, see "Technical Data", page 21.

⚠ CAUTION

- Examine the wiring carefully before power up the device(s) and examine particularly correct connection of the power supply lines.

2.3.1 Rear Panel Installation

- The RCU6512 is made for rear panel installation.
 - The four screws for installation are already attached at the front of the device
"Figure 6: Dimensions RCU6512 (front view)" page 30.
 - For circular cut out and mounting holes see
"Figure 7: Drilling template (rear panel mounting)" page 30.
 - The minimum torque for fixing screws is 0.9 Nm (8 inch-lbs).
 - For device dimensions see "Dimensions - RCU6512" page 33.

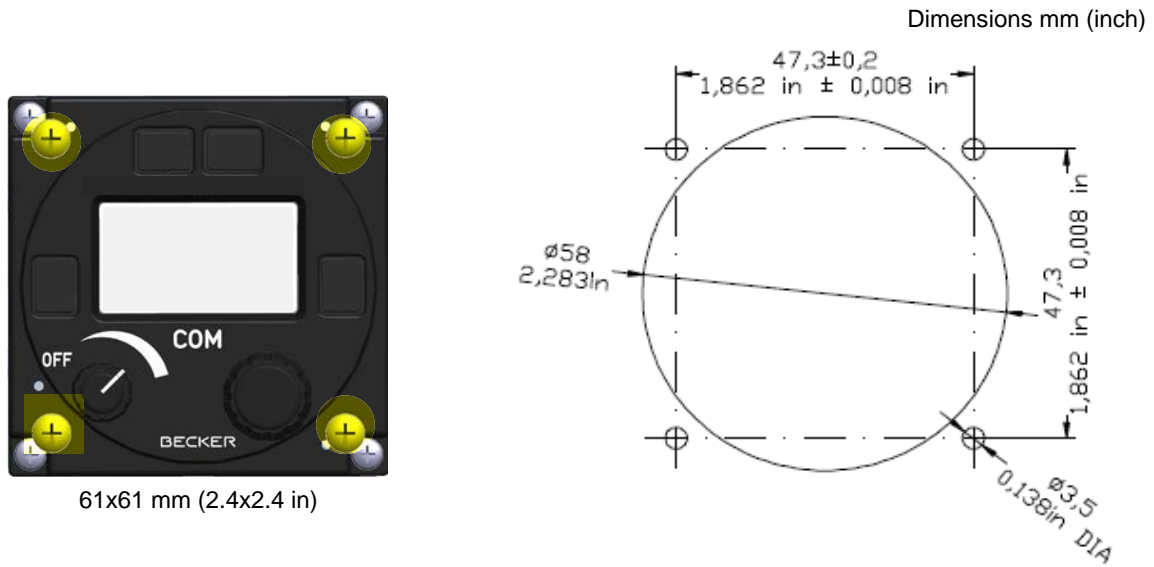

Figure 6: Dimensions RCU6512 (front view)

Figure 7: Drilling template (rear panel mounting)

2.3.2 Audio Volume Interface - Connector Wiring (RCU6512-(3XX) only)

2.3.2.1 Cable&Connector J1

Dimensions mm (inch)

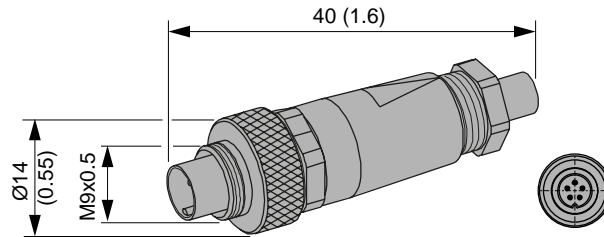

Figure 8: Dimensions - Cable Connector J1

2.3.2.2 Requirements - Cable&Connector J1

- 2x cable twisted pair, shielded e.g. M27500-24SB2T23:
 - Wire gauge: AWG24
 - Cable diameter: max. 2.5 mm
- 1x cable (piece for chassis ground) e.g. KYNAR®:
 - Wire gauge: AWG30
 - Length: 17 mm

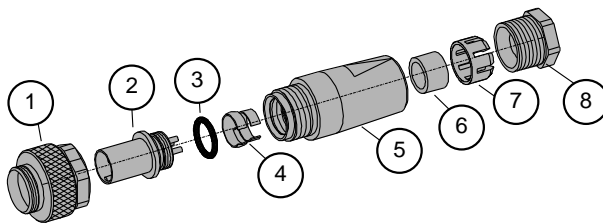

Figure 9: Exploded View - Cable Connector J1

- Pos.1: Connection ring nut
- Pos.2: Connector insert (male)
- Pos.3: O-ring 6x1 (in connector insert)
- Pos.4: Collar (shield)
- Pos.5: Snap bushing
- Pos.6: Seal
- Pos.7: Pinch ring
- Pos.8: Pressing screw

Cable assembly

Instructions

Avoid any excessive, mechanical stress to the parts and the cable.

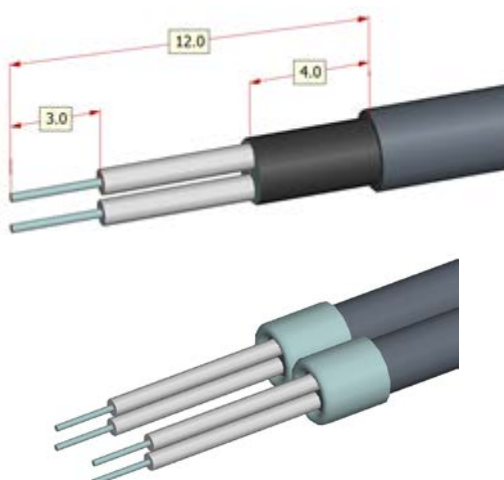

Prepare shielded twisted pair cables (2x):

- Dismantle cable (12 mm).
 - Shorten shield braid (4 mm).
 - Strip wires (3 mm).
-
- Fold shield braids of both cables over the outer cable jacket.

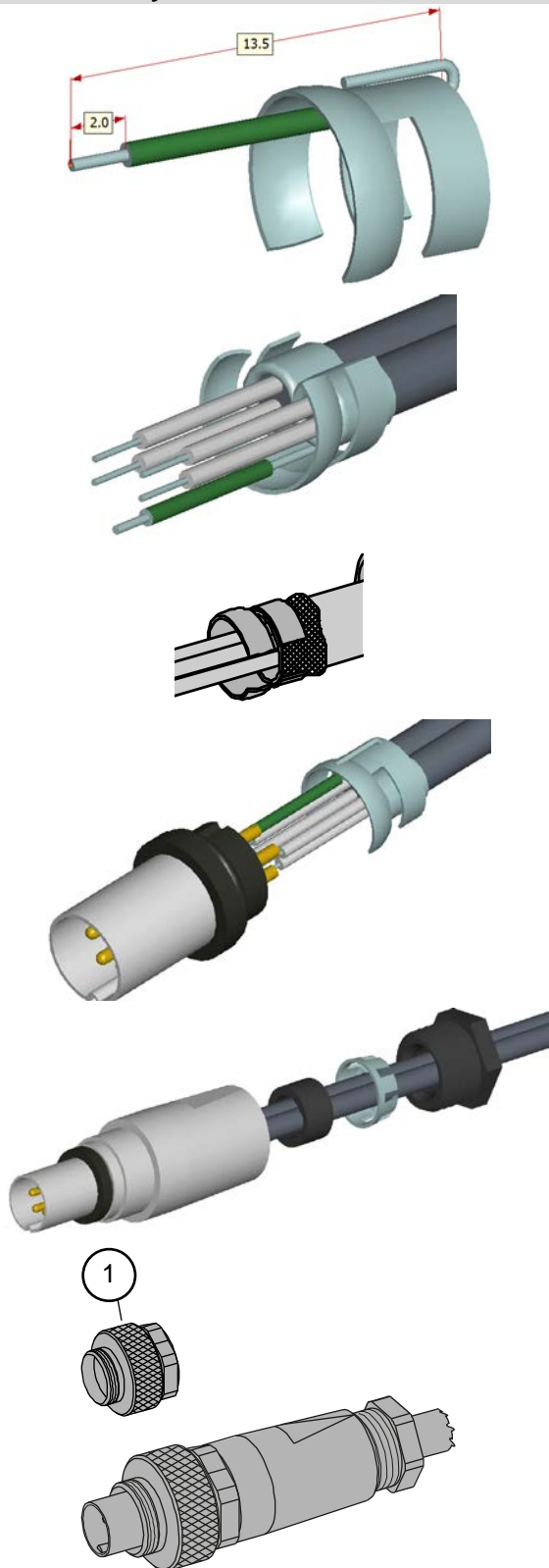
Cable assembly**Instructions****Prepare cable piece (chassis ground):**

Cable: AWG30 17 mm length.

- Strip wire on both ends (1x 2 mm, 1x 8 mm).
- Fold half of the longer stripped wire over the collar clamp (4, part of connector).
- Solder folded wire on the top of collar clamp (4).
- Add the other cables into the collar clamp (4).
- Tighten the collar clamp (4) on the cables over the shield braids and solder them.

Notice:

Total diameter of the collar with cables must not exceed 6 mm.

- Cut off the overlap of the shield braid.

Prepare connector:

- Solder wires to connector insert (2) (pin assignment see "RCU6512-(3XX) - Connector J1 (Audio Connector)" page 37).

Final connector assembly:

- Slide in cables with soldered connector insert (2) into the snap bushing (5).
- Assemble the seal (6), pinch ring (7) and pressing screw (8).
- Tighten pressing screw (8).
- Assemble the connection ring nut (1) and tighten it.

Attention:

- Max. torque of connection ring nut (1) in socket connector 0.50 Nm (manual adjustment).

Figure 10: Cable Assembly - Cable&Connector J1

2.4 Dimensions

2.4.1 RCU6512-(1XX), RCU6512-(2XX)

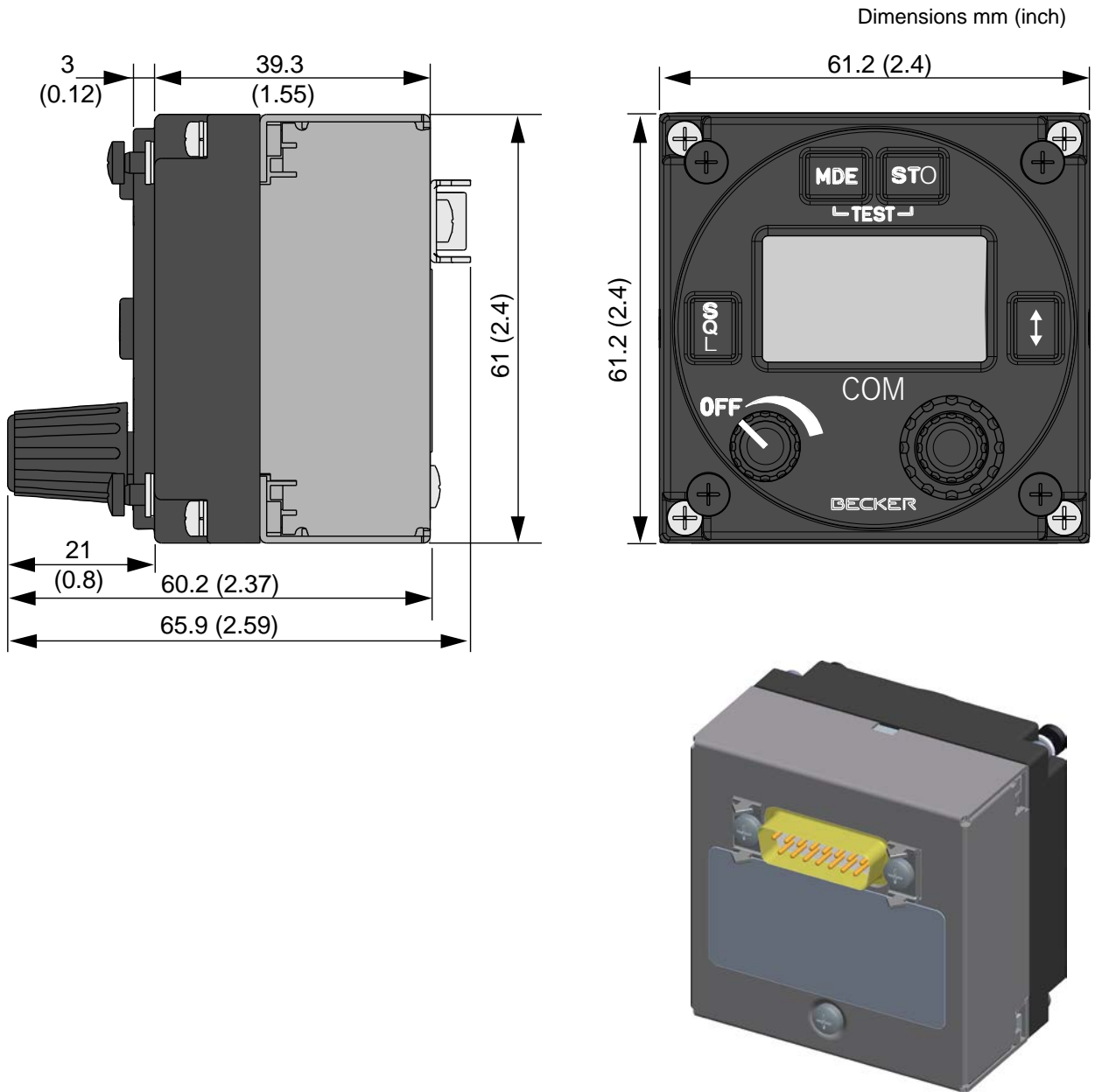

Figure 11: Dimensions - RCU6512-(1XX), RCU6512-(2XX)

Permitted deviation for dimensions without tolerances: DIN ISO 2768 T1 C (dimensions in mm)		
xx...6 (±0.3)	>30...120 (±0.8)	>400...1000 (±2.0)
>6...30 (±0.5)	>120...400 (±1.2)	>1000...2000 (±3.0)

Dimensions

2.4.2 RCU6512-(3XX)

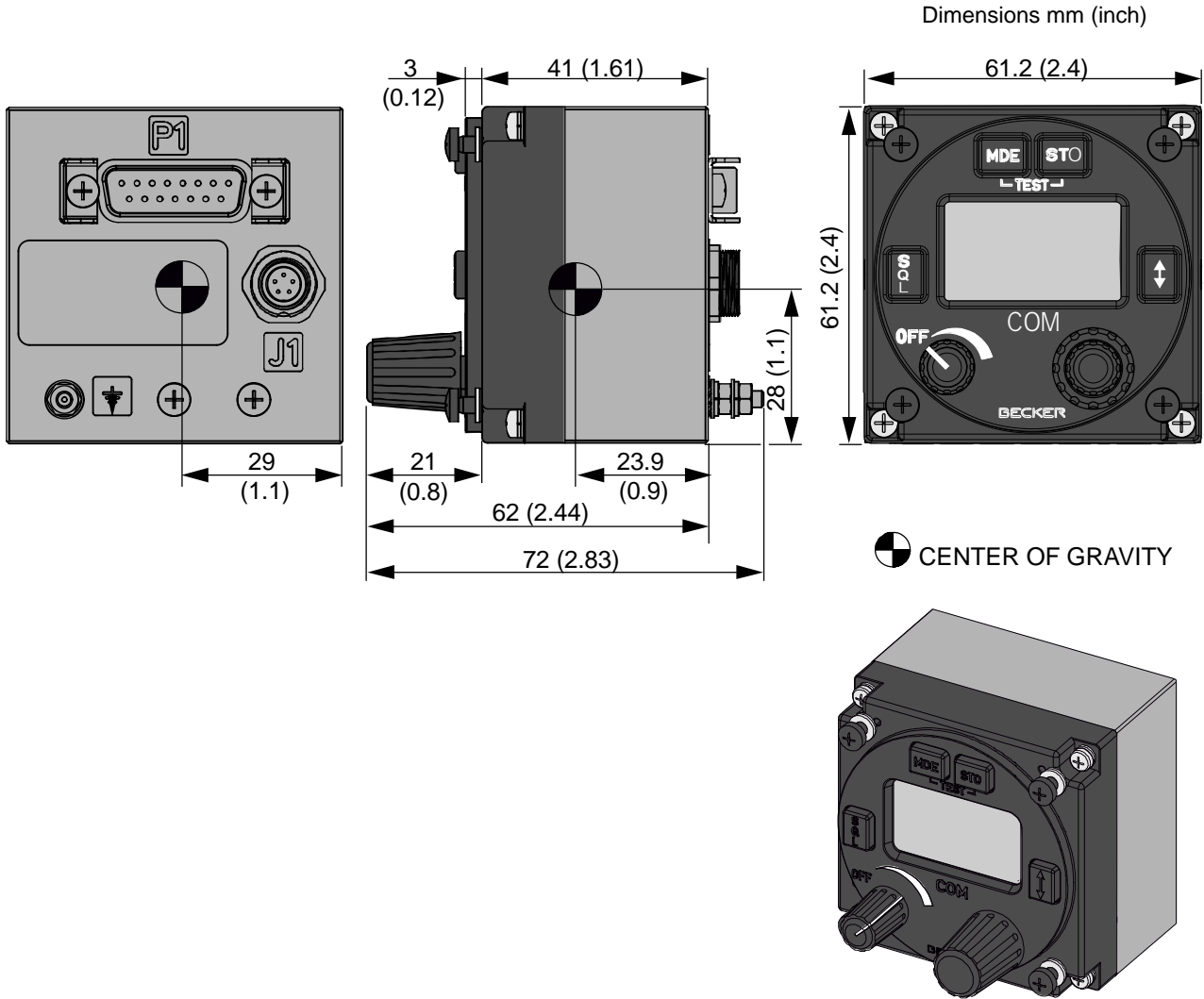

Figure 12: Dimensions - RCU6512-(3XX)

Permitted deviation for dimensions without tolerances: DIN ISO 2768 T1 C (dimensions in mm)		
xx...6 (±0.3)	>30...120 (±0.8)	>400...1000 (±2.0)
>6...30 (±0.5)	>120...400 (±1.2)	>1000...2000 (±3.0)

2.5 Connector Pin Assignments

2.5.1 RCU6512-(1XX), RCU6512-(2XX)

Connector P1

- Type: 15pin D Sub male connector with slide-in fastener.



P1: Device connector

Figure 13: RCU6512-(1XX), RCU6512-(2XX) - Connector Layout

2.5.2 RCU6512-(1XX), RCU6512-(2XX) - Connector P1

P1 Pin	Pin Name	I/O Type	Function
1	TX0_422+	S_OUT	Primary Control & Service Interface
2	TX0_422-	S_OUT	Primary Control & Service Interface
3	Reserved	-	factory only
4	RX0_422+	S_IN	Primary Control & Service Interface
5	RX0_422-	S_IN	Primary Control & Service Interface
6	DIMM_B	C_IN	Dimming input B
7	Reserved	-	factory only
8	DIMM_A	C_IN	Dimming input A
9	GND	PWR	Power supply Ground, shielding for RS422, Ground for discrete lines
10	Reserved	-	factory only
11	SUPP_IN	PWR	Power supply (positive)
12	/6512	D_IN	RT6512 support only, selection pin
13	/EXT_ON	D_IN/OUT	External Power ON input Active state - closed contact to GND
14	Reserved	-	factory only
15	/EXCH_CH	D_IN	External "Exchange" key Active state - closed contact to GND

Connector Pin Assignments

2.5.3 RCU6512 -(3XX)

Connector P1

- Type: 15pin D-Sub male connector with slide-in fastener.

Connector J1

- Type: 5pin circular connector, female

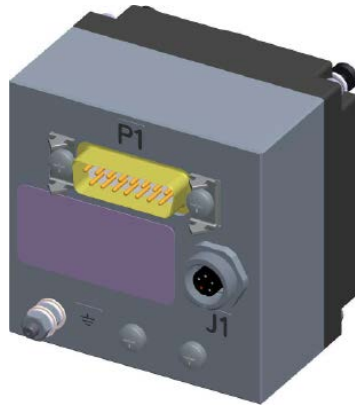

P1: Device connector
J1: Audio connector
⊕ Grounding bolt (M3)

Figure 14: RCU6512-(3XX) - Connector Layout

2.5.4 RCU6512-(3XX) - Connector P1

P1 Pin	Pin Name	I/O Type	Function
1	TX0_422+	S_OUT	COM1: Control Interface OUT+
2	TX0_422-	S_OUT	COM1: Control Interface OUT-
3	RX1_422+	S_IN	COM2: Tandem Synchronization Protocol, Channel Data Base Protocol and Radio Transceiver Synchronization Protocol Interface IN+
4	RX0_422+	S_IN	COM1: Control Interface IN+
5	RX0_422-	S_IN	COM1: Control Interface IN-
6	DIMM_B	C_IN	Dimming input B
7	TX1_422-	S_OUT	COM2: Tandem Synchronization Protocol, Channel Data Base Protocol and Radio Transceiver Synchronization Protocol Interface OUT-
8	DIMM_A	C_IN	Dimming input A
9	GND	PWR	Power supply Ground, shielding for RS422, Ground for discrete lines
10	RX1_422-	S_IN	COM2: Tandem Synchronization Protocol, Channel Data Base Protocol and Radio Transceiver Synchronization Protocol Interface IN-
11	SUPP_IN	PWR	Power supply (positive)
12	/SDI_Sec	D_IN	Secondary RCU selection pin
13	/EXT_ON_CH	D_IN/OUT	External Power ON input Active state - closed contact to GND
14	TX1_422+	S_OUT	COM2: Tandem Synchronization Protocol, Channel Data Base Protocol and Radio Transceiver Synchronization Protocol OUT+
15	/EXCH_CH	D_IN	External "Exchange" key Active state - closed contact to GND

2.5.5 RCU6512-(3XX) - Connector J1 (Audio Connector)

J1 Pin	Pin Name	I/O Type	Function
1	Audio IN_A	AF_IN	Symmetrical audio input line (together with pin 5)
2	Audio OUT_A	AF_OUT	Symmetrical audio output line (together with pin 4)
3	GND	-	Chassis ground (for shielding connection)
4	Audio OUT_B	AF_OUT	Symmetrical audio output line (together with pin 2)
5	Audio IN_B	AF_IN	Symmetrical audio input line (together with pin 1)

2.5.6 Discrete In-/Outputs

Discrete inputs (D_IN) characteristics:	
Input type:	asymmetrical, DC coupled
Closed contact to GND:	$\leq 100 \Omega$
Open contact to GND:	$\geq 100 \text{ k}\Omega$
Resistance activation:	Active state: closed contact to GND
Voltage activation:	Active state: $< 3.5 \text{ V}$ Inactive state: $> 4.5 \text{ V}$

The input must withstand connection of external relay ($R = 200 \Omega$) to power supply line.

Discrete outputs (D_OUT) characteristics:	
Output type:	asymmetrical, "open drain"
	Active state - output line closed to GND: $I_{\text{OUT_C}} \geq 100 \text{ mA}$, $U_{\text{OUT_C}} \leq 0.3 \text{ V}$
	Inactive state - output line open: $I_{\text{OUT_O}} \leq 100 \mu\text{A}$, $U_{\text{OUT_O}} \leq 30 \text{ V}$

2.5.7 Panel Backlight

- The RCU6512 controller push-buttons and display can be highlighted.
- The backlight can be configured in the configuration setup.
 - Configuration through front panel or externally through P1-6/P1-8.

For external configuration:

- Connect P1-6 to system ground and P1-8 to dimming voltage bus.

Pin No.	Pin Name	I/O Type	Function
P1-6	DIMM_B	C_IN	Dimming input B
P1-8	DIMM_A	C_IN	Dimming input A
P1-9	GND	PWR	Power supply ground

2.5.7.1 RCU6512-(1XX), RCU6512-(2XX)

For external configuration:

- Connect P1 8 to the dimming voltage bus positive.
- Connect P1-6 and P1-9 (system ground pin) to the dimming voltage bus negative.

2.5.7.2 RCU6512-(3XX)

For external configuration and 0...5 V dimming bus:

- Connect P1 6 and P1 8 to the dimming bus positive.
- Connect P1-9 (system ground pin) to the dimming bus negative.

For external configuration and 0...14 V and 0...28 V dimming bus:

- Connect P1 8 to the dimming bus positive.
- Connect P1-6 and P1-9 (system ground pin) to the dimming bus negative.

2.5.8 External Power ON (/EXT_ON)

It is possible to power on the system with the "External Power ON" line.

- Active when contact to GND.
- This can be done in installations with a central avionics power switch or to power on RT6512.

Pin No.	Pin Name	I/O Type	Function
P1-13	/EXT_ON	D_IN/OUT	External Power ON input/output ACTIVE state - closed contact to GND

2.5.9 External Exchange (/EXCH_CH)

With the "External Exchange" input it is possible to change the active and preset frequency.

- The RCU6512 has a discrete input /EXCH_CH_IN it accepts an external contact or open collector to ground.

Pin No.	Pin Name	I/O Type	Function
P1-15	/EXCH_CH	D_IN	External "Exchange" key ACTIVE state - closed contact to GND

2.5.10 Selection Pin

2.5.10.1 RCU6512-(1XX), RCU6512-(2XX)

Pin No.	Pin Name	I/O Type	Function
P1-12	/RT6512	D_IN	Closed to GND

2.5.10.2 RCU6512-(3XX)

For single RCU6512-(3XX) installation:

Pin No.	Pin Name	I/O Type	Function
P1-12	/SDI_Sec	D_IN	INACTIVE state - not connected

For tandem operation of two RCU6512-(3XX) with RT6512:

Pin No.	Pin Name	I/O Type	Function
P1-12	/SDI_Sec	D_IN	At primary RCU: <ul style="list-style-type: none"> • INACTIVE state - not connected At secondary RCU: <ul style="list-style-type: none"> • ACTIVE state - closed to GND

- Obey additional requirements for configuration settings and aircraft wiring "RCU6512-(3XX) for Tandem Operation" page 44.

2.6 Equipment Configuration Samples

2.6.1 RCU6512 with RT6512

RT6512 transceiver operated by RCU6512 controller using the RS422 interface.

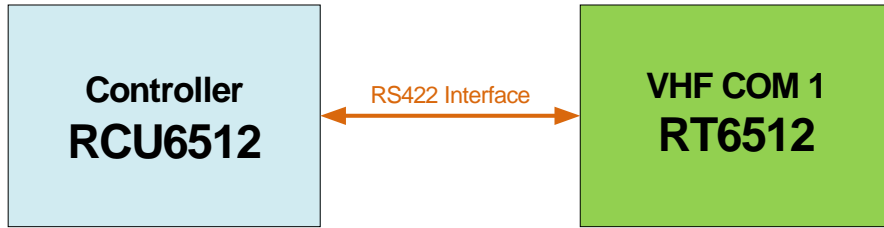

Figure 15: RCU6512 with RT6512

2.6.2 RCU6512-(3XX) Tandem Operation with RT6512

RT6512 transceiver operated by two RCU6512-(3XX) controllers (tandem operation) using the RS422 interface.

- In tandem mode the operation and view are synchronized, both RCU6512-(3XX) show the same information.

Explanation:

- The radio can be controlled directly by RCU1 through COM1.
- RCU1 supports communication with RCU2 through COM2.
- RCU1 and RCU2 communicate through COM2 of RCU1.
- Commands from RCU2, addressed to the radio, are routed through RCU1.
- COM2 of RCU2 uses a tandem protocol for content synchronization.

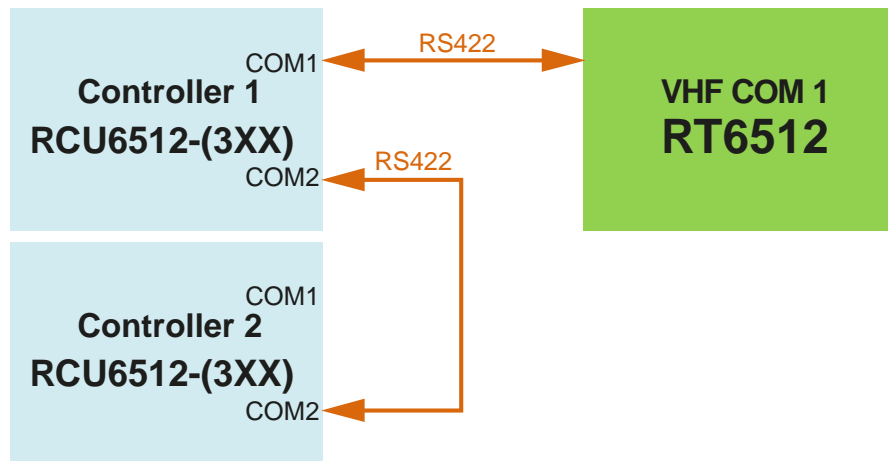

Figure 16: RCU6512 Tandem Operation with RT6512

NOTICE

Configuration with two controllers for tandem operation is only possible with RCU6512-(3XX) and RT6512.

2.6.3 RCU6512-(3XX) – External Channel Data Base Configuration

The channel memory of the RCU6512-(3XX) can be created and managed externally through the software application CDB6512 from Becker Avionics.

NOTICE**Requirements:**

- The related connector must be installed near the primary controller. For further details contact Becker Avionics.

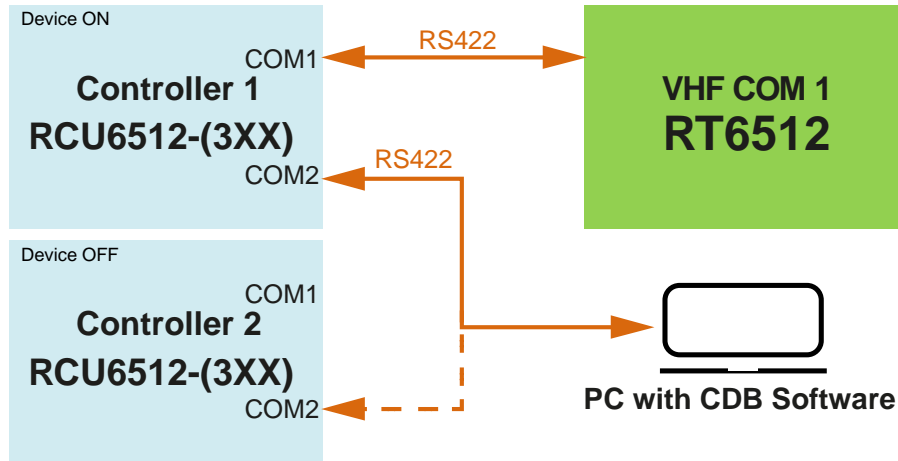

Figure 17: RCU6512 (3XX) – External Channel Data Base Configuration

2.7 Aircraft Wiring

SAFETY INSTRUCTIONS

The installation of the device(s) depends on the type of aircraft and its equipment and therefore only general information can be given in this section.

NOTICE

Configuration with two controllers for tandem operation is only possible with RCU6512-(3XX) and RT6512.

2.7.1 Installation Switch (INS_SW)

It is necessary to install a switch to get access to the RT6512 installation parameters.

- Access to RT6512 installation parameters is only possible when RT6512 /SERV_EN line is connected to ground.
 - RT6512, connector P1/28 → turnkey (INS_SW) → GND.

NOTICE

- Setting of RT6512 installation parameters are available only when installation switch* ("INS_SW" to GND) is closed.
 - Otherwise, settings of RCU6512 installation parameters only will be possible.

* For details see "Figure 18: Wiring - RCU6512-(1XX), RCU6512-(2XX) as Primary Controller", page 43).

2.7.2 Electrical Bonding and Grounding - RCU6512-(3XX)

SAFETY INSTRUCTIONS

- Make sure that the device is correctly connected to aircraft ground (structure).
- Make sure that the electrical bonding area is protected to prevent corrosion.
- Make sure that the resistance between the bonding component and any point of this item of equipment do not exceed 20 mΩ.

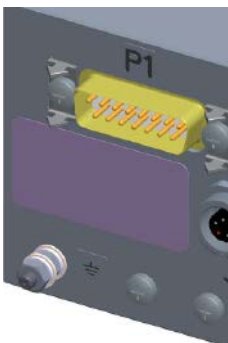

RCU6512-(3XX)

⊥ Grounding bolt

- The device has a M3 threaded grounding bolt at the rear side.
- Use this grounding bolt to do a low impedance grounding of the device.
 - Max. tightening torque for ground screw: 1.5 Nm (14 inch-lbs).
 - Wire cross section: min. 4 mm² (AWG11).
 - Length: max. 150 mm (6 in).

2.7.3 Wiring - RCU6512-(1XX), RCU6512-(2XX) as Primary Controller with RT6512

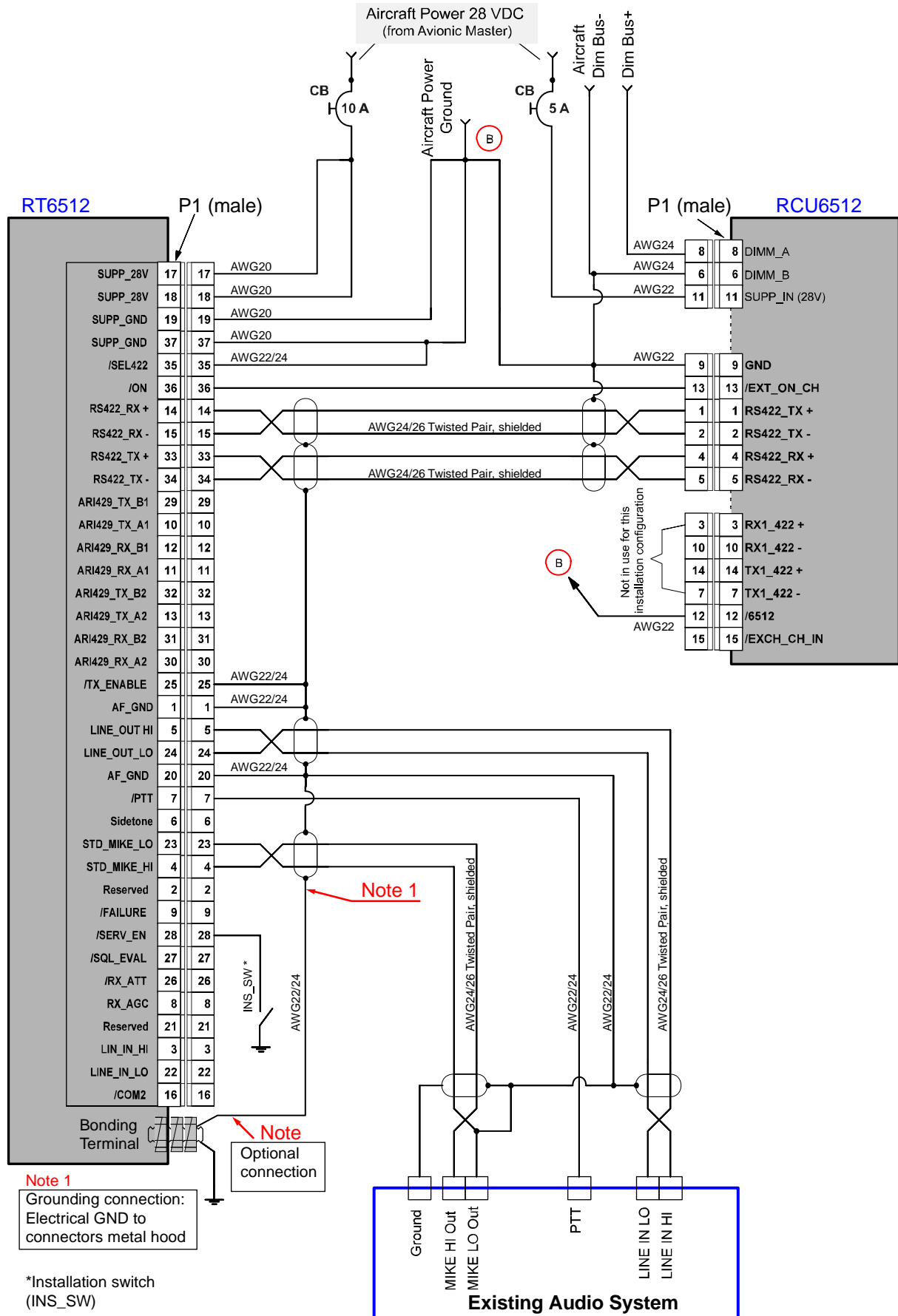

Figure 18: Wiring - RCU6512-(1XX), RCU6512-(2XX) as Primary Controller with RT6512

2.7.4 RCU6512-(3XX) for Tandem Operation with RT6512

2.7.4.1 Configuration - Two RCU6512-(3XX) for Tandem Operation with RT6512

Device: RT6512	
Status	Value
P1 pin5, LINE_OUT_HI	Set to maximum 0 dB (factory setting)

Enabled Disabled Selected De-Selected

Device: RCU6512-(3XX) Primary	
Status	Value
/SDI_Sec	Wiring: P1 pin12, not connected
Installation Mode	<input checked="" type="checkbox"/> TANDEM ENABLE

Device: RCU6512-(3XX) Secondary	
Status	Value
/SDI_Sec	Wiring: P1 pin12, closed to GND
Installation Mode	<input checked="" type="checkbox"/> TANDEM ENABLE
Configuration	<p>The second controller must be turned off.</p> <ul style="list-style-type: none"> • After power on, the second controller synchronizes the parameters with the parameters of the primary controller. • Any stored parameters in second controller will be overwritten.

2.7.4.2 Wiring -Two RCU6512-(3XX) for Tandem Operation with RT6512

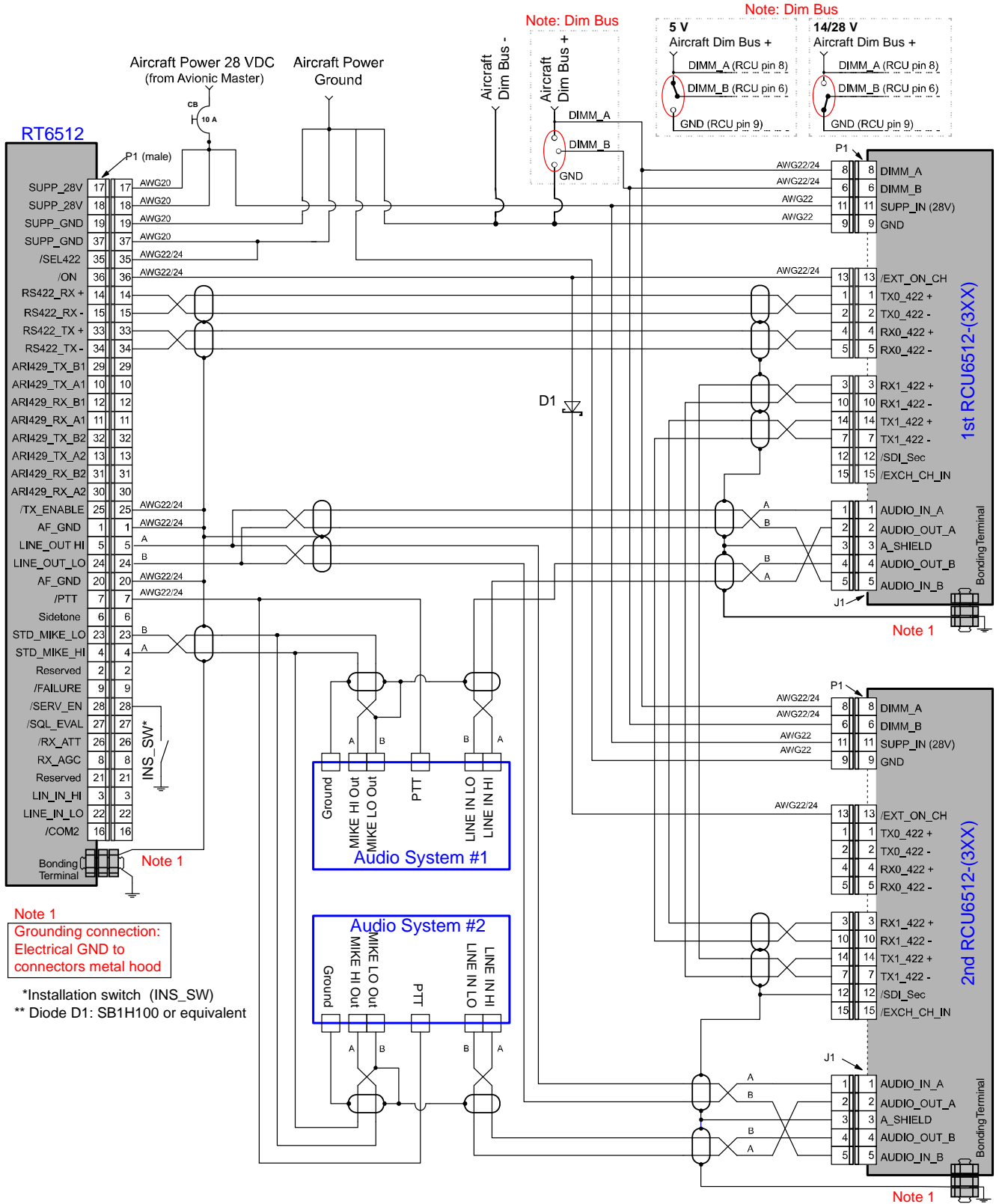

Figure 19: Wiring - Two RCU6512 (3XX) for Tandem Operation with RT6512

2.8 Configuration-Setup

The configuration setup is for the avionics technician to set up the equipment configuration on ground.

Service Modes	Description
Configuration Mode (CFG MODE)	Adjustments for the control device (RCU6512) and for the controlled transceiver (RT6512).
Installation Mode (INS MODE)	Adjustments for the control device (RCU6512) and for the controlled transceiver (RT6512) protected by a password.

Configuration and installation adjustments are stored in the non-volatile memory of the RCU6512.

NOTICE

Several functions and settings are only available through the password-protected "Installation Mode" (INS MODE) and active installation switch* (INS_SW to GND).

* For details see wirings e.g. "Aircraft Wiring", page 42).

NOTICE

It is not recommended to do changes on the configuration setup in-flight.

Normally the configuration is done with the primary controller.

- The primary controller at the remote-controlled device is the one connected to primary control interface.
- If installed, the second controller must be turned off.
- After power-on, the second controller synchronizes the parameters with the parameters of the primary controller.
 - Any stored parameters in second controller will be overwritten.
 - Synchronization of selection modes (Standard Mode, Direct Tune Mode, Channel Mode)
 - Synchronization of operating functions (mode, spacing, frequency, channel, storage, squelch selection function, TX indication).
 - Synchronization of selected configuration and installation settings.

2.8.1 Installation Mode (INS MODE)

NOTICE



- The change of RT6512 installation parameters is only possible when installation switch* is closed (INS_SW to GND).
- When installation switch* (INS_SW) is open the change of RCU6512 installation parameters is possible.

* For details see wirings e.g. "Aircraft Wiring", page 42).

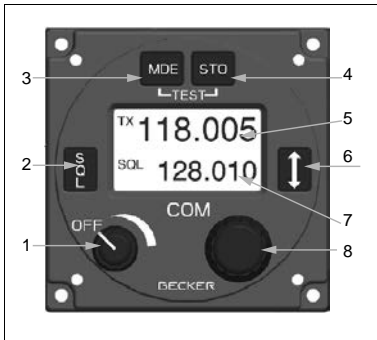

2.8.1.1 Start Installation Mode



Details for RCU front panel description see "Controls and Indications" page 64.

Display Contents	Description
	<ul style="list-style-type: none"> • Activate installation switch ("INS_SW"), if installed. • Push and hold the "MDE" key during power up to get access to the configuration/installation mode.
 <p>Figure 20: "CFG MODE"</p>	<ul style="list-style-type: none"> • The display shows "CFG MODE". • Push "MDE" key.
 <p>Figure 21: "INS MODE"</p>	<ul style="list-style-type: none"> • The display shows "INS MODE". • Push rotary encoder push button.

2.8.1.2 RCU - Password

Display Contents	Setting of RCU parameters
 <p>Figure 22: "PASSWORD 0000"</p>	<ul style="list-style-type: none"> • The display shows "PASSWORD". • Use the rotary encoder to set the password.
 <p>Figure 23: "PASSWORD"</p>	<ul style="list-style-type: none"> • Enter the 4-digit code "6435" by turning and pushing the rotary encoder (push to toggle between digits). • Push "STO" key to accept password.

2.8.1.3 RCU - Contrast, Dimming Input

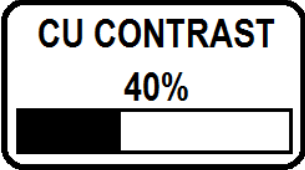
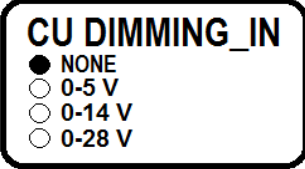
Display Contents	Setting of RCU parameters
 <p>Figure 24: "CU CONTRAST"</p>	<ul style="list-style-type: none"> • The display shows "CU CONTRAST". • Use the rotary encoder to set contrast level. • Push rotary encoder push button.
 <p>Figure 25: "CU DIMMING_IN"</p> <p>View only at secondary RCU (tandem)</p>	<ul style="list-style-type: none"> • The display shows "CU DIMMING_IN". • Select required input. <ul style="list-style-type: none"> ○ NONE: A dimming voltage at the dimming input lines will be ignored and "CU BRIGHTHESS" is available through "Configuration Mode" ○ +5 VDC, +14 VDC or +28 VDC: RCU6512 brightness will be controlled remotely by dimming input lines. ○ Maximum brightness level will be achieved for dimming voltage +5 V, +14 V or +28 V respectively. • Push "STO" key to accept selection. • Push rotary encoder push button.

2.8.1.4 RCU - Tandem

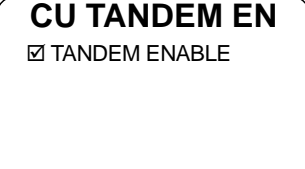
Display Contents	Setting of RCU parameters
 <p>Figure 26: "CU TANDEM EN"</p>	<p>Tandem adjustment is only available and possible with RCU6512-(3XX) variants.</p> <ul style="list-style-type: none"> • The display shows "CU TANDEM EN". • Use "STO" key to select/deselect check box. • Push "STO" key to accept selection.

2.8.1.5 RCU - Memory

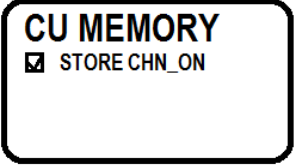
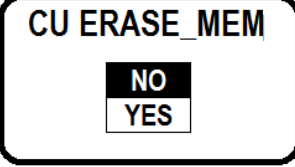
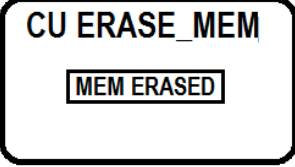
Display Contents	Setting of RCU parameters
 <p>Figure 27: "CU MEMORY"</p> <p>View only at secondary RCU (tandem)</p>	<ul style="list-style-type: none"> The display shows "CU MEMORY". <p>With "STORE CHN_ON" the store function of memory channels will be enabled.</p> <ul style="list-style-type: none"> Use "STO" key to select/deselect check box. Push rotary encoder push button.
 <p>Figure 28: "CU ERASE_MEM"</p>	<ul style="list-style-type: none"> The display shows "CU ERASE_MEM". <p>To erase memory channels:</p> <ul style="list-style-type: none"> Select "YES" with the rotary encoder Push "STO" key to accept selection.
 <p>Figure 29: "CU ERASE_MEM"</p>	<ul style="list-style-type: none"> The display shows "CU ERASE_MEM". <p>Notice: RCU6512-(1XX): Only one memory bank, the memory channels for current selected channel spacing is erased. To erase the second memory bank, change the channel spacing and repeat the erase procedure. For details please refer to: "Start Configuration Mode" page 53 → Channel Spacing page 55. RCU6512-(3XX): After power on, the second controller synchronizes the parameters with the parameters of the primary controller. Any stored parameters in second controller will be overwritten. i.e. if RCU1 has an empty memory, the memory of RCU2 is also erased by the synchronization.</p>

2.8.1.6 RT – Parameters – General (INS MODE)

NOTICE On secondary RCU in tandem installation all RT6512 settings are hidden.

Display Contents	Setting of RT6512 parameters
	<p>Notice: The change of RT6512 installation parameters is only possible when installation switch* ("INS_SW" to GND) is closed. For details see e.g. wiring "Figure 18: Wiring - RCU6512-(1XX), RCU6512-(2XX) as Primary Controller", page 43 or "Wiring -Two RCU6512-(3XX) for Tandem Operation with RT6512", page 45.</p>

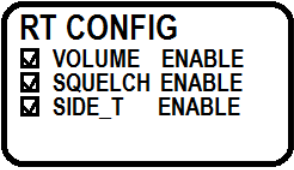

2.8.1.7 RT - Volume, Squelch, Sidetone

Display Contents	Setting of RT6512 parameters
 <p>Figure 30: "RT CONFIG"</p>	<ul style="list-style-type: none"> • Push rotary encoder push button. The display shows "RT CONFIG". <p>Select/deselect check boxes to set the function allowed or blocked.</p> <ul style="list-style-type: none"> • Use rotary encoder to navigate between the functions. • Use "STO" key to select/deselect check boxes. • Push "STO" key to accept selection. <p>VOLUME ENABLE RCU6512-(1XX): <input checked="" type="checkbox"/> Enabled, the volume level can be controlled with the volume knob. <input type="checkbox"/> Disabled, the volume level is "frozen" at the value that was set at the time of deactivation (de-selection).</p> <p>RCU6512-(3XX): Setting in not required, because the volume level of RT6512 is always set to maximum regardless of the volume knob adjustment.</p> <p>SQUELCH ENABLE <input checked="" type="checkbox"/> Enabled, it is possible to set the squelch function on and off from the RCU panel (SQL push button). <input type="checkbox"/> Disabled, squelch function on and off is not possible.</p> <p>SIDE_T ENABLE <input checked="" type="checkbox"/> Enabled, RT6512 supplies sidetone signal to the LINE_OUT during transmission. <input type="checkbox"/> Disabled, RT6512 mutes sidetone signal on LINE_OUT during transmission.</p>

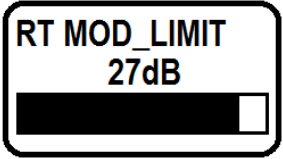
2.8.1.8 RT - Audio Input Sensitivity (RT MOD_LIMIT)

Display Contents	Setting of RT6512 parameters
 <p>Figure 31: "RT MOD_LIMIT"</p>	<ul style="list-style-type: none"> • Push rotary encoder push button. • The display shows "RT MOD_LIMIT". <p>Notice: "RT MOD_LIMIT" is shown only when installation switch* is closed ("INS_SW" to GND). For details see e.g. wiring "Figure 18: Wiring - RCU6512-(1XX), RCU6512-(2XX) as Primary Controller", page 43 or "Wiring -Two RCU6512-(3XX) for Tandem Operation with RT6512", page 45.</p> <ul style="list-style-type: none"> • The "RT MOD_LIMIT" setting is for audio input sensitivity adjustment. <ul style="list-style-type: none"> ○ Minimum value of 5 dB correspond to minimum sensitivity (approx. 3 V_{RMS} at "MIKE_IN" and 6 V_{RMS} at "LINE_IN" to achieve 70% modulation) ○ Maximum value of 31 dB corresponds to maximum sensitivity (100 mV_{RMS} at "MIKE_IN" and 200 mV_{RMS} at "LINE_IN"). <p>Notice: Pay special attention when setting the input sensitivity.</p> <ul style="list-style-type: none"> • Start adjustment from the minimum. • Speak into the microphone as loudly as you would normally talk (do not shout). Maintain a constant voice level to record the modulation depth measurement. • Obey (measure) the modulation coefficient of the transmitted signal and increase the setting until the modulation depth is approximately 80...85%. • If the recipient of the transmitted message notices a "metallic" sound, the input limit is possibly exceeded. In this case the value of RT MOD_LIMIT must be decreased.

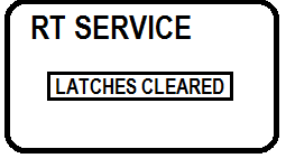
2.8.1.9 RT - Service

 <p>Figure 32: "RT SERVICE"</p> 	<ul style="list-style-type: none"> • Push rotary encoder push button. • The display shows "RT SERVICE". • "CLEAR LATCHES": All error flags stored in RT6512 memory will be cleared. • Use rotary encoder to navigate between the functions. • Push "STO" key to accept selection. <ul style="list-style-type: none"> ○ The display shows "LATCHES CLEARED".
 	<ul style="list-style-type: none"> • "RECALL SERVICE": All installer settings will be recovered to the factory default settings*. • Use rotary encoder to navigate between the functions. • Push "STO" key to accept selection. <ul style="list-style-type: none"> ○ The display shows "RECALL DONE". <p>*Factory default please see "Factory Default Settings" page 58.</p>

2.8.2 Configuration Mode (CFG MODE)

	<p>Details for RCU front panel description see "Controls and Indications" page 64.</p>
--	--

2.8.2.1 Navigate between Pages

- Use the rotary encoder push button to navigate between the pages of the configuration mode.

2.8.2.2 Cancel Configuration Mode

- Turn off the RCU6512 to cancel the setup.
 - All changes made up to this time will be stored automatically.

2.8.2.3 Start Configuration Mode

Display Contents	Description
<p>Figure 33: "CFG MODE"</p>	<ul style="list-style-type: none"> • Push and hold the "MDE" key during power up to get access to the configuration mode. • The display shows "CFG MODE". • Push rotary encoder push button.

2.8.2.4 RCU - Device Info

Display Contents	Description
<p>Figure 34: "CU DEV_INFO"</p>	<ul style="list-style-type: none"> • The display shows "CU DEV_INFO". <p>Device info about:</p> <ul style="list-style-type: none"> ○ RCU6512 software version. ○ RCU6512 serial number.

2.8.2.5 RCU - Brightness

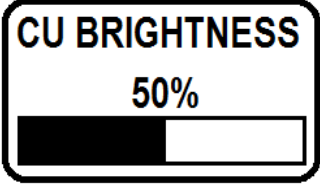
Display Contents	Configuration Mode (RCU6512)
 <p>Figure 35: "CU BRIGHTNESS"</p>	<p>"BRIGHTNESS": The brightness of the LCD and push-buttons can be adjusted between 0% (off) and 100%.</p> <ul style="list-style-type: none"> Use the rotary encoder to select the brightness. <p>Notice: "CU BRIGHTNESS" screen is shown only if dimming input is set to "NONE". Otherwise the aircraft dimming bus will control the brightness.</p>

2.8.2.6 RCU6512-(1XX), RCU6512-(2XX) - Dimming

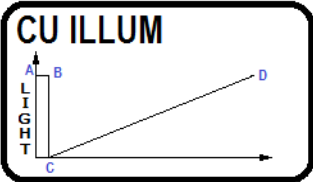
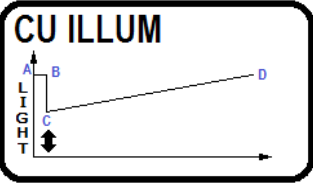
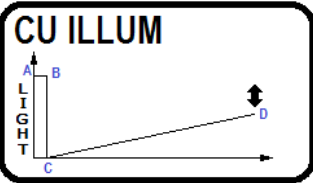
Display Contents	Configuration Mode (RCU6512-(1XX))
 <p>Figure 36: "CU ILLUM"</p>	<p>Dimming ("CU ILLUM") The dimming curve shows the relation between dimming bus voltage and brightness of the LCD and push-buttons.</p> <ul style="list-style-type: none"> Two adjustable points C and D define the dimming curve. Select the respective parameter by pushing the "STO" button Then adjust the value in vertical (up/down) direction with the rotary encoder.
	<p>Notice: "CU ILLUM" screen is shown only if the "DIMMING_IN" is selected for 5 V, 14 V or 28 V dimming bus voltage. If the dimming voltage is not available (0 V or high impedance), the brightness of the display backlight and switches backlight change to maximum (100%)</p>
	<ul style="list-style-type: none"> Parameter "C" is the level of minimum brightness which is set when related trigger point of dimming voltage is reached. Parameter "D" is the level of maximum brightness when maximum dimming voltage is applied to the dimming input.

2.8.2.7 RCU6512-(3XX) - Dimming

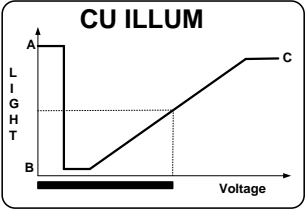
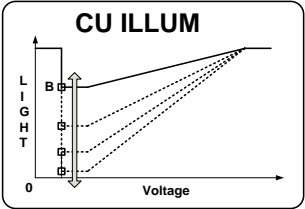
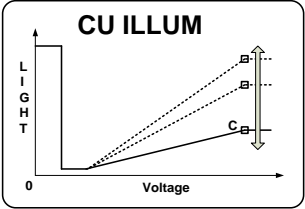
Display Contents	Configuration Mode (RCU6512-(3XX))
 <p>Figure 37: "CU ILLUM"</p>  	<p>Dimming ("CU ILLUM") The dimming curve shows the relation between dimming bus voltage and brightness of the LCD and push-buttons.</p> <ul style="list-style-type: none"> • Two adjustable points B and C define the dimming curve. • Select the respective parameter by pushing the "STO" button • Then adjust the value in vertical (up/down) direction with the rotary encoder. <p>Notice: "CU ILLUM" screen is shown only if the "DIMMING_IN" is selected for 5 V, 14 V or 28 V dimming bus voltage. If the dimming voltage is not available (0 V or high impedance), the brightness of the display backlight and switches backlight change to maximum (100%)</p> <ul style="list-style-type: none"> • Parameter "B" is the level of minimum brightness which is set when related trigger point of dimming voltage is reached. • Parameter "C" is the level of maximum brightness when maximum dimming voltage is applied to the dimming input.

2.8.2.8 RCU - Channel Spacing

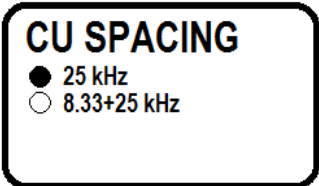
Display Contents	Configuration Mode (RCU6512)
 <p>Figure 38: "CU SPACING"</p> <p>View only at secondary RCU (tandem)</p>	<p>Channel spacing ("CU SPACING") "CU SPACING" is to select the frequency channel spacing modes.</p> <ul style="list-style-type: none"> • Use the rotary encoder to select the channel spacing mode. • Push "STO" key to accept selection.

2.8.2.9 RT – Parameters – General (CFG MODE)

NOTICE

On secondary RCU in tandem installation all RT6512 settings are hidden.

2.8.2.10 RT - Device Info

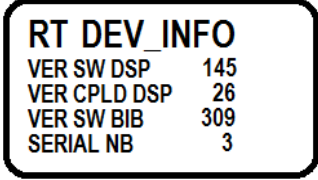
Display Contents	Configuration Mode (RT6512)
 <p>Figure 39: "RT DEV_INFO"</p>	<ul style="list-style-type: none"> The display shows "RT DEV_INFO". <p>Device info (main information) about the controlled RT6512 transceiver.</p>

2.8.2.11 RT - Squelch Threshold (RT SQL_LEVEL)

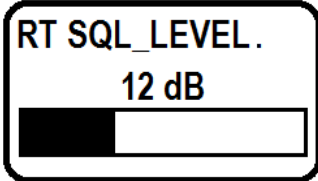
Display Contents	Configuration Mode (RT6512)
 <p>Figure 40: "RT SQL_LEVEL"</p>	<p>Squelch threshold level ("RT SQL_LEVEL") The noise squelch threshold "RT SQL_LEVEL" is adjustable in a range of 6...23. Use the rotary encoder for adjustment.</p> <ul style="list-style-type: none"> Minimum adjustment of 6 (very weak signals are audible with high noise content; squelch opens at about -105 dBm) means: <ul style="list-style-type: none"> Weak RF signals can trigger the squelch threshold. The voice signal might be low combined with a noisy background. Maximum adjustment of 23 (only quite strong signals are audible with low noise content; squelch opens at about -87 dBm) means: <ul style="list-style-type: none"> Only strong RF signals will trigger the squelch threshold. The voice signal will be audible clear with very low background noise. Weak RF signals may not trigger the squelch threshold and therefore the audio may not be heard by the pilots. <p>Notice: For very weak RF signals receiver audio level might be reduced.</p>

2.8.2.12 RT - Sidetone Attenuation (RT SIDE_LEVEL)

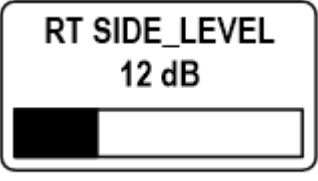
Display Contents	Configuration Mode (RT6512)
 <p>Figure 41: "RT SIDE_LEVEL"</p>	<p>Sidetone attenuation ("RT SIDE_LEVEL") The attenuation relates to the received volume setting.</p> <ul style="list-style-type: none"> 0 dB = sidetone as loud as received signal. 12 dB = sidetone signal is 12 dB less than the received signal.

2.8.2.13 RT - Operating Time (RT TIME)

Display Contents	Configuration Mode (RT6512)
 <p>Figure 42: "RT TIME"</p>	<p>Operating time ("RT TIME") Information about operating time of RT6512 transceiver.</p>

2.8.2.14 RT - Temperature (RT TEMP)

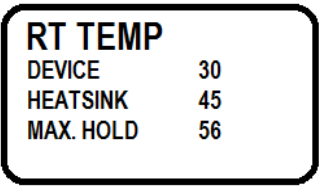
Display Contents	Configuration Mode (RT6512)
 <p>Figure 43: "RT TEMP"</p>	<p>Temperature ("RT TEMP") Information about temperature of RT6512 transceiver.</p>

2.8.2.15 RT - Failure History (RT ERR_LATCH)

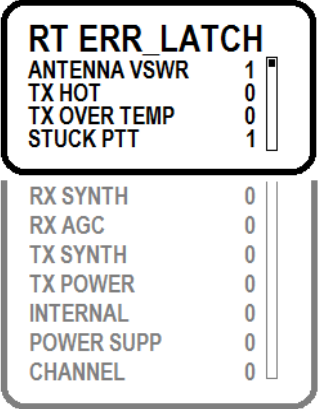
 <p>Figure 44: "RT ERR_LATCH"</p>	<p>Failure history ("RT ERR_LATCH") The display can only show 4 rows of monitored failure types (scroll bar for more).</p> <ul style="list-style-type: none"> • Move the scroll bar with the rotary encoder to show additional failures. <ul style="list-style-type: none"> ○ 0 = no failure. ○ 1 = failure found and stored once or more than once.
--	---

Factory Default Settings

2.9 Factory Default Settings**2.9.1 RCU6512-(1XX), RCU6512 (2XX)**

Enabled Disabled Selected De-Selected

Setting name	Value
CU BRIGHTNESS	50%
CU SPACING	<input type="radio"/> 25 kHz <input checked="" type="radio"/> 8.33/25 kHz
CU CONTRAST	40%
CU DIMMING_IN	<input checked="" type="radio"/> NONE <input type="radio"/> 0-5 V <input type="radio"/> 0-14 V <input type="radio"/> 0-28 V
CU MEMORY	<input checked="" type="checkbox"/> STORE CHN_ON
CU ERASE_MEM	No channels stored

2.9.2 RCU6512-(3XX)

Enabled Disabled Selected De-Selected

Setting name	Value
CU BRIGHTNESS	50%
CU SPACING	<input type="radio"/> 25 kHz <input checked="" type="radio"/> 8.33/25 kHz
CU CONTRAST	40%
CU DIMMING_IN	<input checked="" type="radio"/> NONE <input type="radio"/> 0-5 V <input type="radio"/> 0-14 V <input type="radio"/> 0-28 V
CU MEMORY	<input checked="" type="checkbox"/> STORE CHN_ON
CU ERASE_MEM	No channels stored
CU TANDEM EN	<input checked="" type="checkbox"/> TANDEM ENABLE

2.10 Post Installation Check

Notice: Do the "Configuration Setup" before you start the Post Installation Tests.

After the device/system is installed completely do a test. Make sure that the compliance with the authority required procedures is obeyed.

2.10.1 Mechanical Installation and Wiring Check

- Make sure that all cables are attached and the shields are connected to ground.
- Examine the movement of controls to make sure that there is no interference.
- Make sure that all screws are tight and the connectors of the device are secured.

2.10.2 Power Supply

- Examine the power supply lines and the correct polarity.
- Make sure that the power supply is in the specified limits, with and without an engine that is in operation.

2.10.3 Receiver / Transmitter Operation

- Power up the device/system and tune it to a local station for a communication test.
- Make sure that the receiver output supplies a clear and readable audio and ask the local station for correct readability for the transmit signal.

2.10.3.1 Tandem Installation

NOTICE

Configuration with two controllers for tandem operation is only possible with RCU6512-(3XX) and RT6512.

- Power up both of RCU6512-(3XX).
- Select a channel/frequency on the primary RCU.
 - The display on the secondary RCU must show the same channel/frequency.
- Select a channel/frequency on the secondary RCU.
 - The display on the primary RCU must show the same channel/frequency.

2.10.4 Flight Test Check

It is highly recommended to do a flight test to make sure the function of the RCU6512 with controlled RT6512.

- Contact a ground station at a range of at least 50 NM while maintaining an applicable altitude and over all normal flight attitudes.
- Examine the performance in the low, mid and high band frequencies.

2.11 Troubleshooting

Problem	Proposed Solution
Display shows "FAILURE"	Please refer to: "Warning and Failure Indications" page 77.

Blank Page

3 Operation

In this chapter you can read about:

3.1	General.....	61
3.2	Device Description	62
3.2.1	Available Channel / Frequency Memory.....	62
3.2.2	Device Assignment	63
3.2.3	Packing, Transport, Storage	63
3.2.4	Scope of Delivery.....	63
3.2.5	State of Delivery.....	63
3.2.6	Type Plate.....	63
3.2.7	Controls and Indications	64
3.2.7.1	Symbols on the Display	65
3.3	Start-Up.....	65
3.4	Receive and Transmit Mode	66
3.4.1	Receive Mode	66
3.4.2	Transmit Mode	66
3.5	Frequency Selection Modes	67
3.5.1	Standard Mode	68
3.5.2	Direct Tune Mode	69
3.5.3	Channel Mode.....	70
3.5.3.1	Selection of Channels.....	71
3.6	Frequency Storage Functions	71
3.6.1	Store "Active Frequency"	72
3.6.2	Automatic Storage Function (LAST)	73
3.6.3	Store "Preset Frequency"	74
3.6.4	Channel Memory Erase	75
3.7	Squelch (SQL).....	76
3.7.1	Squelch Threshold.....	76
3.8	Channel Spacing.....	76
3.9	Brightness	76
3.10	Warning and Failure Indications	77
3.11	Contact Data	79

3.1 General

This section contains general information and instructions for safe operation.

3.2 Device Description

The system of RCU6512 and transceiver is for voice communication between aircraft or between an aircraft and ground stations, using the very high frequency band between 118.000...155.975 MHz (depends on RT6512 variant) with a selectable channel spacing of 25 kHz respectively 8.33 kHz.

3.2.1 Available Channel / Frequency Memory

RCU6512-(1XX), RCU6512-(2XX):

- The RCU6512-(1XX) can store up to 40 frequencies assigned to channel numbers in two user channel memories.
 - 20 channels reserved for 25 kHz channels spacing mode.
 - 20 channels reserved for 8.33/25 kHz channel spacing mode.

RCU6512-(3XX):

- The RCU6512-(3XX) can store 99+9 frequencies assigned to channel numbers in two channel memories.
 - 99 channels reserved for the channel spacing modes 8.33/25 kHz in the user channel memory.
 - The last recently used 9 (active) frequencies are stored as "LAST" channels in the LAST channel memory.

NOTICE

- Several functions and settings are only available through the password-protected "Installation Mode" and "Configuration Mode"*.
- Some functions are only available when they are enabled for the user in the configuration-setup*.

* For details please refer to: "Installation Mode" page 46 and "Configuration Mode" page 53.

NOTICE

- The figures for illustrating display show transceivers working in 8.33/25 kHz mixed mode.
- Dedicated pictures for 25 kHz mode are not explicitly shown (they differ only in number of digits for frequency).
- The HMI actions described in this section can be done on RCU6512 controlling VHF transceiver RT6512.
- The word "frequency" also used in the sense of "channel name", as defined in EUROCAE, document ED-23C chapter 1.3.2. In this document the word "memory channel" or "channel" means a memory place identified by a channel number, where a frequency can be stored for later use.

NOTICE

Excessive pulses on the DC bus of the aircraft can damage the electrical circuits of any installed instrument.

Do not turn on the device during engine start or shutdown.

**SAFETY
INSTRUCTIONS**

Do a voice communication test before starting any operation.

- Notice that, if the communication test is carried out close to a ground station, the results can be positive even if the antenna cable is broken or short-circuited.
 - **Caution!** Then a communication might not be possible at 5...10 km and above.
- Speak always loud, clear and not too fast for optimal voice communication.
- Keep the microphone always close to the lips otherwise a special suppressing circuit in the VHF COM will not be capable to suppress normal noise.
- Use only microphones or headsets which are applicable for specific installations.
 - In aircraft made of wood, synthetic materials or in gliders or helicopters, incoming radiation can affect the integrated amplifier of the microphone (feedback), then the ground station receives a whistling and/or heavy distortion.

3.2.2 Device Assignment

This manual is valid for the devices:

- See page 27

3.2.3 Packing, Transport, Storage

- See page 26

3.2.4 Scope of Delivery

- See page 27

3.2.5 State of Delivery

- See page 27

3.2.6 Type Plate

- See page 28

3.2.7 Controls and Indications



Figure 45: RCU6512 - Controls and Indications

	Symbol	Description	Function
1		Power ON/OFF, Volume Knob	<ul style="list-style-type: none"> Turns the transceiver ON/OFF and is used to adjust the volume level of received signal.
2		SQL (Squelch)	<ul style="list-style-type: none"> "Short push" during normal operation toggles the RX - SQL ON/OFF.
3		MDE (Mode)	<ul style="list-style-type: none"> "Short push" during normal operation changes the frequency selection mode.
4		STO (Store)	<ul style="list-style-type: none"> "Short push" during normal operation starts the storage procedure.
	-TEST-	IBIT Activation	<ul style="list-style-type: none"> Push and hold the MDE and STO button at the same time for > 2 s starts IBIT when RT6512 is in RX-mode.
5		Active frequency	Only on the active frequency: <ul style="list-style-type: none"> Transmission is possible. Frequency tuning is not possible in standard mode.
6		↕ (Exchange)	<ul style="list-style-type: none"> "Short push" during standard mode toggles between preset and active frequency.
7		Preset frequency	<ul style="list-style-type: none"> Frequency tuning is possible in standard mode.
8		Rotary encoder	<ul style="list-style-type: none"> Turn the rotary encoder to change the selected parameters (frequency, channel number ...). Push the rotary encoder to select digits. Push the rotary encoder to accept the adjustment.

The device detects a:

"Long push": when you push and hold down a key for > 2 seconds.

"Short push": any push < 2 seconds.

If any action by the user is invalid, the whole display inverting for a short time.

3.2.7.1 Symbols on the Display

Symbol	Function
TX	The transceiver is in transmit operation.
SQL	Squelch function is active, weak RX signals will be suppressed.
STO	The transceiver is in a storage procedure.
128.225	Inverted figures or letters on the display are selected to change.
CH	An already used channel is shown in uppercase letters.
ch	A free channel is shown in lowercase letters.
LAST1...9	Automatically stored frequency when a newly selected frequency is constant for more than 30 seconds

3.3 Start-Up

NOTICE

Excessive pulses on the DC bus of the aircraft may cause damage on electrical circuits of any installed instrument.

Do not turn on the device during engine start or shutdown.

- Turn on the device by turning the volume knob clockwise.
- After power-on, the device starts a self-test (PBIT).
 - The display shows the message "WAIT".
 - **Tandem installation:** The secondary RCU shows the message "WAIT" until the tandem synchronization is completed.
- If there is an error the display shows the message "FAILURE (for details see "Warning and Failure Indications" page 77).
- During normal operation, a self-test (CBIT) permanently examines the correct operation of the device.
 - If there is an error the display shows an error message.

3.4 Receive and Transmit Mode

3.4.1 Receive Mode

- If /PTT (Push-To-Talk) input is inactive, the transceiver remains in receive mode.
- In receive mode the line output signal consists of:
 - Received signal from antenna.

3.4.2 Transmit Mode



- If PTT input is active (PTT=Push-To-Talk key is pushed) the transceiver changes to transmit mode.
 - Microphone or LINE_IN signal can modulate the transmitter.
- The "TX" symbol shows the device is in transmitting mode.
- The sidetone (demodulated audio of the emitted signal) is available on the headphone output (condition: Sidetone functionality is enabled in configuration-setup).



- In transmit mode some user actions such as change of frequency selection mode or channel, which are normally allowed in receive mode, are blocked.
(As an exception in standard mode the "Preset" frequency is changeable, even during transmission).



- Transmit mode is automatically stopped (return to receive mode) after 30 s of continuous transmission.
"FAILURE" is shown, see "Warning and Failure Indications", page 77.

3.5 Frequency Selection Modes

Available modes:

- Standard mode
- Direct tune mode
- Channel mode

Standard Mode	Direct Tune Mode	Channel Mode
118.005 127.000	118.005 <small>SQL</small>	127.000 ch 01

The modes "Standard Mode", "Direct Tune Mode" and "Channel Mode" have different layouts for the selection of the operating frequency.

- The modes are selectable with a short push of the "MDE" key, one after the other.
 - The display shows one by one: "Standard Mode", "Direct Tune Mode", "Channel Mode", "Standard Mode", and so on.
- With the changes from "Standard Mode" to "Direct Tune Mode" the active frequency stays the same.
- RCU6512-(1XX), RCU6512-(2XX):
 - With the change from "Direct Tune Mode" to "Channel Mode" the before selected memory channel is selected.
- RCU6512-(3XX):
 - With the change from "Direct Tune Mode" to "Channel Mode" the active frequency stays the same.
- With the change from "Channel Mode" to "Standard Mode" the before active and preset channels are selected.

3.5.1 Standard Mode



- Push the "MDE" key to change to the standard mode page.
- The active frequency is shown in the top line and preset frequency in the bottom line.
- The change of the active frequency is not possible in standard mode (only available in direct tune mode).
- The change of the preset frequency is possible.

Change the preset frequency in standard mode:

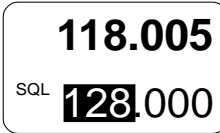

- Do a short push on the rotary encoder for modification of the MHz digits.
 - The changeable digits are shown inverted.
- Turn the rotary encoder clockwise/counterclockwise to change the frequency in 1 MHz steps.

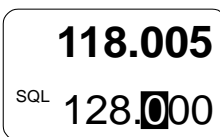

- Do another "short push" on the rotary encoder for modification of the 100 kHz digit.
 - The changeable digit is shown inverted.
- Turn the rotary encoder clockwise/counterclockwise to change the frequency in 100 kHz steps.

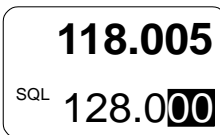

- Do another "short push" on the rotary encoder for modification of the 25/8.33 kHz digits.
 - The changeable digits are shown inverted.
- Turn the rotary encoder clockwise/counterclockwise to change the frequency in 25/8.33 kHz steps.

Cancel preset frequency setting:

- Wait 5 seconds for timeout.
- Push and hold rotary encoder button > 2 seconds.

NOTICE

- A short push of the "↕" key, exchanges active frequency to preset frequency and vice versa.
 - While the transceiver operates in transmit mode, the exchange function is disabled.
- Push the "STO" key to store the active frequency into the next vacant memory position of the user channel database (see "Frequency Storage Functions", page 71).

3.5.2 Direct Tune Mode

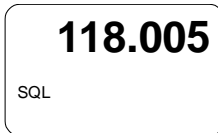

- Push the "MDE" key to change to the direct tune mode page.
 - The active frequency is shown in the top line.

Change the active frequency in direct tune mode:



- Do a short push on the rotary encoder for modification of the MHz digits.
 - The changeable digits are shown inverted.
- Turn the rotary encoder clockwise/counterclockwise to change the frequency in 1 MHz steps.

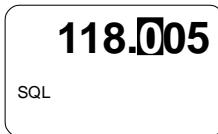

- Do another "short push" on the rotary encoder for modification of the 100 kHz digit.
 - The changeable digit is shown inverted.
- Turn the rotary encoder clockwise/counterclockwise to change the frequency in 100 kHz steps.

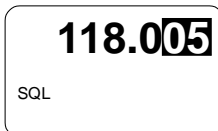

- Do another "short push" on the rotary encoder for modification of the 25/8.33 kHz digits.
 - The changeable digits are shown inverted.
- Turn the rotary encoder clockwise/counterclockwise to change the frequency in 25/8.33 kHz steps.

Cancel active frequency setting:

- Wait 5 seconds for timeout.
- Push and hold rotary encoder button > 2 seconds.

NOTICE

- The changes are active immediately.
 - While the transceiver transmits, the change of the active frequency is not possible.
- Push the "STO" key to store the active frequency into the next vacant memory position of the user channel database (see "Frequency Storage Functions", page 71).

3.5.3 Channel Mode

The channel mode is for operating with stored data (frequencies) from memory.

127.000

ch **01**

RCU6512-(1XX), RCU6512-(2XX) memory:

- 2x 20 user channels:
 - 20 channels reserved for 25 kHz channels spacing mode.
 - 20 channels reserved for 8.33/25 kHz channel spacing mode.

RCU6512-(3XX) memory:

- 1x 99 user channels.
- 9 auto store channels (LAST).

NOTICE

- When the device operates in the 25 kHz mode a selection of stored 8.33 kHz channels/frequencies is not possible.
- For selection of 8.33 kHz channels/frequencies, the device must operate in 8.33/25 kHz mixed mode.
- CH: Used channels are shown with uppercase letters (CH).
- ch: Free channels are shown with lowercase letters (ch).

NOTICE

The word "frequency" also used in the sense of "channel name", as defined in ICAO Annex 10, Volume 5, chapter 4.1.2.

In this document the word "memory channel" or "channel" means a memory place identified by a channel number, where a frequency can be stored for later use.

127.000

ch **01**

- Push the "MDE" key to change to the channel mode page.
- The top line shows the frequency related to the selected channel number.
- If channel memory is empty (ch):
 - Toggling from "Direct Tune Mode" to "Channel Mode" does not change active frequency.
 - The bottom line shows channel number "ch01".

122.000

CH **09**

- If any frequency is already stored (CH):
 - The top line shows the stored frequency to the last selected channel number.
 - The bottom line shows the related channel number "CH..".
- With the channel number the stored frequencies can be selected.

3.5.3.1 Selection of Channels

NOTICE

The functions store/restore are only available if they are activated in the configuration setup* - ("RCU - Memory" page 49).

* For details please refer to: "Configuration-Setup" page 46.

122.000
CH 01



127.500
CH 02

125.875
SQL LAST 1

RCU6512-(3XX) only:

- The first turn counterclockwise (rotary encoder) starts the auto store channel memory. It starts always with LAST 1.
 - The channel number is now highlighted.
 - One of the nine last used channels is selectable.
- Turn the rotary encoder to select a channel.
- Do a short push to the rotary encoder to confirm the channel and leave the auto store channel memory.

Cancel channel number setting:

- Wait 5 seconds for timeout.
- Push and hold rotary encoder button > 2 seconds.

Cancel channel mode:

- Push the "MDE" key.
 - The channel mode will be closed.
 - The standard mode page is shown.

3.6 Frequency Storage Functions

Storage methods:

- Store "Active Frequency".
- Store "Preset Frequency".

NOTICE

The functions store/restore are only available if they are activated in the configuration setup*.

* For details please refer to: "Configuration-Setup" page 46.

3.6.1 Store "Active Frequency"

Store "Active Frequency"

Step A

118.005
127.000

"Standard Mode"

- Push "STO" key (in "Standard Mode", "Direct Tune Mode" or "Channel Mode").

118.005

"Direct Tune Mode"

118.005
CH 01

"Channel Mode"

Step B

118.005
STO ch 09

- The symbol "STO" is shown on the left side.
- The first empty memory channel is selected.
 - Select the offered free channel number or another channel number for storage.
- Push "STO" key.
 - The frequency is stored in the memory and available with the related channel number.
 - The storage procedure will be left.

Step C

118.005
127.000

"Standard Mode"

- RCU changes to the before used operating mode (when procedure was started from "Standard" or "Direct Tune Mode").
- RCU changes to new stored channel number (when procedure was started from "Channel Mode").

118.005

"Direct Tune Mode"

118.005
CH 09

"Channel Mode"

NOTICE

- Frequencies can be stored on an already used channel number.
- **Please notice: The previously stored data will be overwritten.**

NOTICE

During transmission in channel mode the STO function is not possible/available.

3.6.2 Automatic Storage Function (LAST)

RCU6512-(3XX) only:

The RCU6512-(3XX) stores recently selected frequencies. Named and callable as LAST 1...LAST 9.

- With the change to a new active frequency, the before selected active frequency is stored in memory as LAST 1.
 - The frequencies stored in LAST 1...LAST 8 are shifted to memory channels LAST 2...LAST 9.

Notice: **The functions Store/Restore are only available if they are enabled in the configuration setup* - (page "RCU - Memory").**

* (Details see "Configuration-Setup" page 46).

3.6.3 Store "Preset Frequency"

Store "Preset Frequency"

Step A



"Standard Mode"

- Push "STO" key (in "Standard Mode", "Direct Tune Mode" or "Channel Mode").



"Direct Tune Mode"

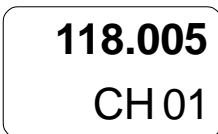

"Channel Mode"

Step B

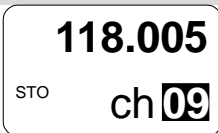

- The symbol "STO" is shown on the left side.
- The first empty memory channel is selected.
 - Select the offered channel number or another free channel for storage.

Step C...E

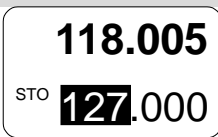

- Do a short push on the rotary encoder for modification of the MHz digits.
 - The changeable digits are shown inverted.
- Turn the rotary encoder clockwise/counterclockwise to change the frequency in 1 MHz steps.

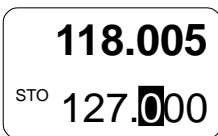

- Do another "short push" on the rotary encoder for modification of the 100 kHz digit.
 - The changeable digit is shown inverted.
- Turn the rotary encoder clockwise/counterclockwise to change the frequency in 100 kHz steps.

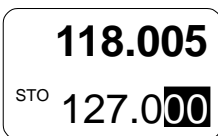

- Do another "short push" on the rotary encoder for modification of the 25/8.33 kHz digits.
 - The changeable digits are shown inverted.
- Turn the rotary encoder clockwise/counterclockwise to change the frequency in 25/8.33 kHz steps.

Step F

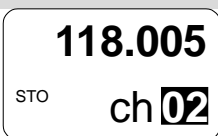

- Do a short push on the rotary encoder for modification of the memory channel number.
- Push "STO" key.
- The frequency is stored in the memory and available with the related channel number.
- The storage procedure will be left.

Store "Preset Frequency"

Step G

118.005

127.000

"Standard Mode"

- RCU changes to the before operating mode (when procedure was started from "Standard" or "Direct Tune Mode").
- RCU change to new stored channel number (when procedure was started from "Channel Mode").

118.005

"Direct Tune Mode"

127.000**CH 02**

"Channel Mode"

NOTICE

- Frequencies can be stored with an already occupied channel number.
- **Please notice: Before stored data will be overwritten.**

NOTICE

During transmission in channel mode the STO function is not possible/available.

Overview - The data can be stored to:

- Next free channel (offered from system).
- A self-selected free channel.
- A selected used channel (the existing data will be overwritten).

3.6.4 Channel Memory Erase

- The stored data in channel memory can only be deleted in the "Installation Mode" (details see "Installation Mode" page 46).
- RCU6512-(1XX), RCU6512-(2XX):
 - Please notice only one memory bank, the memory channels for current selected channel spacing will be deleted.
 - To delete the second memory bank it is necessary to change to the related channel spacing and then repeat the procedure (details see "Start Configuration Mode" page 53 → Channel Spacing page 55).
- RCU6512-(3XX):
 - After power on, the second controller synchronizes the parameters with the parameters of the primary controller. Any stored parameters in second controller will be overwritten .i.e. if RCU1 has an empty memory, the memory of RCU2 is also erased by the synchronization.

3.7 Squelch (SQL)

This function operates independently of the selected operation menu (condition: Squelch functionality is enabled in configuration setup)..

- A short push on "SQL" key changes the function to "ON" or "OFF".

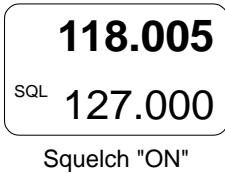

- If the squelch function is active ("ON") the audio noise is muted.

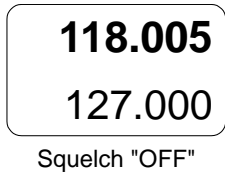

- If the squelch is "OFF" the audio noise is audible as long as the signal is received.

3.7.1 Squelch Threshold

The squelch threshold is adjustable* to an applicable trigger level.

* For details please refer to: "Start Configuration Mode" page 53 → Squelch threshold level ("RT SQL_LEVEL").

3.8 Channel Spacing

The transceiver can operate in 8.33 kHz and 25 kHz frequency channel spacing.

* For details please refer to: "Start Configuration Mode" page 53 → "Channel spacing ("CU SPACING")" page 55.

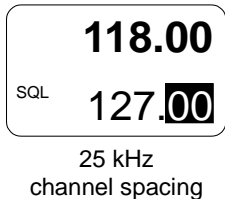

- In 25 kHz mode, 5 frequency digits are shown.
 - Only operating frequencies with a channel spacing of 25 kHz are selectable.
 - This mode has a faster tuning because it does not show the 8.33 kHz frequency steps.

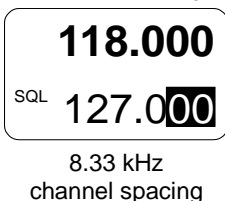

- In 8.33 /25 kHz mixed mode 6 frequency digits are shown.
 - The transceiver tunes to all possible frequencies in the aviation VHF frequency band.

NOTICE

- The selection of 8.33 kHz channels is possible up to 136.99166 MHz (channel name 136.990).
- For frequencies > 136.99166 MHz only 25 kHz channels are selectable.

3.9 Brightness

The brightness of the LCD and push-buttons can be adjusted in "Configuration Mode".

* For details please refer to: "Start Configuration Mode" page 53 → "BRIGHTNESS"

3.10 Warning and Failure Indications

Display Contents	Description
WAIT	<p>"WAIT" screen during start-up.</p> <ul style="list-style-type: none"> Normally maximum 5 s in view then next message.
TEST	<p>"TEST" screen during Initiated Built-In-Test (IBIT).</p>
FAILURE	<p>"FAILURE" is shown when ANTENNA VSWR error is detected.</p> <p>Possible reasons:</p> <ul style="list-style-type: none"> Disconnected or defected antenna cable or defect antenna. HW or SW failure inside the transceiver. <p>Contact maintenance shop for assistance.</p>
FAILURE	<p>"FAILURE" is shown when heatsink temperature exceeds +85 °C (TX HOT error).</p> <ul style="list-style-type: none"> Transceiver is still operable. Performance of transmitter is reduced. "FAILURE" goes out of view when heatsink temperature decreases to less +75 °C <p>Possible reasons:</p> <ul style="list-style-type: none"> Very hot environmental temperature, long transmissions times and insufficient airflow conditions.
FAILURE	<p>"FAILURE" is shown when heatsink temperature exceeds +95 °C (TX OVERTEMP error).</p> <ul style="list-style-type: none"> Transceiver is operable only in receive mode. Transmission is blocked. "FAILURE" goes out of view when heatsink temperature decreases to less +85 °C <p>Possible reasons:</p> <ul style="list-style-type: none"> Very hot environmental temperature, long transmissions times and insufficient airflow conditions.
FAILURE	<p>"FAILURE" is shown after 30 s of continued transmission (STUCK PTT Error).</p> <ul style="list-style-type: none"> The transceiver changes to receive mode even if the PTT line is still active (GND). "FAILURE" goes out of view after push of any key or rotary encoder button and is shown again after 5 s with no action. "FAILURE" goes out of view permanently when PTT line becomes inactive (open). <p>Possible reasons:</p> <ul style="list-style-type: none"> Transmission lasts more than 30 seconds. PTT-key is stuck. PTT line permanently grounded (short circuit in installation).

Warning and Failure Indications

Display Contents	Description
<div style="border: 1px solid black; border-radius: 10px; padding: 5px; text-align: center; width: fit-content; margin: auto;">FAILURE</div>	<p>"FAILURE" is shown when:</p> <ul style="list-style-type: none"> • RX SYNTH error is detected. • RX AGC error is detected. • TX SYNTH error is detected. • TX POWER error is detected. • INTERNAL error is detected. <p>Possible reasons:</p> <ul style="list-style-type: none"> • HW or SW failure inside the transceiver. <p>Contact maintenance shop for assistance.</p>
<div style="border: 1px solid black; border-radius: 10px; padding: 5px; text-align: center; width: fit-content; margin: auto;">FAILURE</div>	<p>"FAILURE" is shown when:</p> <ul style="list-style-type: none"> • POWER SUPP error is detected. • CHANNEL error is detected. <p>Possible reasons:</p> <ul style="list-style-type: none"> • HW or SW failure inside the controller. • HW or SW failure inside the transceiver. <p>Contact maintenance shop for assistance.</p>

3.11 Contact Data

In case of additional questions contact your local Becker Avionics dealer or forward your request direct to Becker Avionics "Customer Service".

In the event of damage or a defect, the entire device must be returned for repair. The repair must be done by trained Becker Avionics personnel.

For department and addresses, please see contact info page 2.

Any change by the user excludes any liability on our part (excluding the work described in this manual).

4 Index

"RT SQL_LEVEL"	56	Non-Warranty Clause	10
Abbreviations	8	RECALL SERVICE	52
Accessories	24	RT CONFIG	50
Airworthiness	21	RT Failure history.....	57
Associated Devices	14	RT MOD_LIMIT	51
Automatic Storage Function	73	RT Operating time.....	57
CLEAR LATCHES	52	RT SERVICE.....	52
Conditions of Utilization	10	RT Squelch threshold level	56
CU CONTRAST	48	RT Temperature.....	57
CU DEV_INFO.....	53, 56	Safety Definitions	9
CU ERASE_MEM	49	Sidetone level.....	56
CU ILLUM	54, 55	Type Plate	28
CU MEMORY	49	Units	9
CU SPACING	55	Variants Overview	14
Dimensions	33	Warning and Failure Indications	77
DIMMING_INPUT	48	Warranty Conditions	10
Installation Requirements	29		

We reserve the right to make technical changes.
 The data match the current status at the time of printing.
 © by Becker Avionics GmbH / all rights reserved

***** End of the Document *****