

BECKER AVIONICS

Beacon Decoder

BD406

PBD406

Installation and Operation

Manual DV16401.03

Issue 04 May 2021

Article-No. 0629.294-071

Approved Production and Maintenance Organization

Certificates see: <http://www.becker-avionics.com/certification/> →Certificates

Contact data for:

**Europe, Asia,
Oceania and
Africa** **Becker Avionics GmbH**
Baden-Airpark B108
77836 Rheinmünster (Germany)
Tel.: +49 7229 305-0
Fax: +49 7229 305-217
Internet: www.becker-avionics.com
Email: info@becker-avionics.com

Customer Service:
Email: support@becker-avionics.com

Contact data for:

**America,
Australia, Japan** **Becker Avionics Inc.**
Email: info@beckerusa.com



WARNING - USER RESPONSIBILITY

FAILURE OR IMPROPER SELECTION OR IMPROPER USE OF THE PRODUCTS DESCRIBED HEREIN OR RELATED ITEMS CAN CAUSE DEATH, PERSONAL INJURY AND PROPERTY DAMAGE.

This document and other information from Becker Avionics provide product or system options for further investigation by users having technical knowledge.

The user is responsible for making the final selection of the system and components. The user has to assure that all performance, endurance, maintenance, safety requirements of the application are met and warnings be obeyed.

For this the user has to include all aspects of the application to be compliant with the applicable industry standards and the requirements of the responsible aviation authority. The product documentations from Becker Avionics have to be obeyed.

To the extent that Becker Avionics provide component or system options based upon data or specifications provided by the user, the user is responsible for determining that such data and specifications are suitable and sufficient for all applications and reasonably foreseeable uses of the components or systems.

Term definition: User in the sense of user, installer, installation company.

Preface

Dear Customer,

Thank you for purchasing a Becker Avionics product. We are pleased that you have chosen our product and we are confident that it will meet your expectations.

For development and manufacturing of our product, the guidelines for highest quality and reliability have been borne in mind, supplemented by selection of high-quality material, responsible production and testing in accordance with the standards.

Our competent customer support department will respond on any technical question you may have. Please do not hesitate to contact us at any time.

Beacon Decoder BD406 & PBD406*



BD406-(XX1)
single block decoder with control head

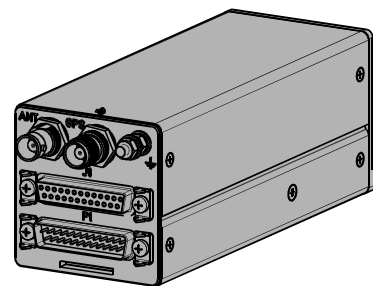

BD406-(XX3)
single block remote decoder without control head



PBD406-(XXX)
portable device with power supply and accessories

* design depends on variant.

* Some figures in this manual are for basic understanding and can be different to the actual design.

List of Effective Pages and Changes

Only technical relevant modifications are described in this table.

Document: DV16401.03 issue 04		Article Number 0629.294-071	
Cover Page	05/2021		
Introduction	05/2021		
Chapter 1 – 4	05/2021		
Issue	Page No.:	Section / Chapter	Description
04	1-112	all	Updated: Editorial adjustments.
	--	all	Added: New variant BD406-(003)
	--		
	--		
	--		
	--		
	--		
	--		
	--		
	--		
	--		
	--		
	--		
	--		
	--		
	--		

© by Becker Avionics GmbH / all rights reserved

Table of Contents

1	General Description	13
1.1	Introduction	14
1.2	Purpose of Equipment.....	15
1.3	Variants Overview	16
1.4	Scope of Functionality.....	17
1.4.1	Beacon / NavPoint Indication.....	18
1.4.2	Beacon / NavPoint Memory	18
1.4.3	Power Supply - BD406	19
1.4.4	Power Supply - PBD406	19
1.4.5	Audio Outputs	19
1.4.6	Illumination.....	19
1.4.7	Audio Notifications	19
1.4.8	Internal GPS Receiver	20
1.4.9	Built-In Tests	20
1.4.10	Installation Setup	20
1.4.11	Service Mode	20
1.5	Safety-Conscious Utilization	21
1.6	Cleaning and Disinfection of Devices	22
	Procedure:.....	22
1.7	Restriction for Use.....	22
1.8	Technical Data	23
1.8.1	Power Supply - BD406	23
1.8.2	Power Supply - PBD406	23
1.8.3	General Characteristics	24
1.8.4	Dimensions & Weight - BD406	26
1.8.5	Dimensions & Weight - PBD406.....	26
1.8.6	Continued Airworthiness.....	27
1.8.7	Environmental Conditions.....	28
1.8.8	Certifications	29
1.9	Order Code	30
1.9.1	BD406, PBD406.....	30
1.9.2	Accessories.....	30
1.9.3	Spare Parts	31
1.9.4	Documentation.....	31
2	Installation.....	33
2.1	Packaging, Transport, Storage	34
2.2	Device Assignment	35
2.2.1	Scope of Delivery.....	35
2.2.2	State of Delivery.....	35
2.2.3	Additional Equipment.....	35
2.2.4	Type Plate.....	36
2.2.5	Software/Firmware Status – Functionality	36
2.3	Installation Requirements.....	37
2.3.1	Rear Panel Installation - BD406 with Control Head.....	38
2.3.2	Avionic Bay Installation - BD406 without Control Head.....	38
2.3.3	Installation - PBD406	39
2.4	Dimensions	40
2.4.1	BD406 with Control Head	40
2.4.2	BD406 without Control Head	41
2.4.3	BD406 without Control Head with Mounting Kit MK4401	42
2.4.4	PBD406.....	43
2.4.5	Bracket for Vehicle Installation	44
2.5	Electrical Interface.....	45
2.5.1	Connector Pin Assignments - BD406	45
2.5.2	Connector Pin Assignments - PBD406.....	51
2.5.3	Inputs / Outputs.....	52
2.6	Aircraft Wiring.....	57
2.6.1	Electrical Bonding and Grounding	57
2.6.2	Wiring - BD406 with Control Head, P1 Connector and Antennas	58
2.6.3	Wiring - BD406 with Control Head, J1 Connector (PBD406 J6 Connector).....	59
2.6.4	Wiring - BD406 without Control Head, P1 Connector and Antennas	60

2.6.5	Wiring - BD406 without Control Head, J1 Connector	61
2.6.6	Antenna Installation.....	62
2.7	Installation Setup	62
2.7.1	Start Installation Setup	62
2.7.2	Device Info	63
2.7.3	General Configuration	64
2.7.4	Audio Warnings.....	65
2.7.5	Dimming Input	65
2.7.6	Brightness	66
2.7.7	Illumination Curve	66
2.7.8	Load Default.....	67
2.7.9	GPS Source Selection	68
2.7.10	External GPS Receiver Configuration.....	68
2.7.11	Target Status Protocol	68
2.7.12	ARINC 429	69
2.7.13	GPO_0	69
2.7.14	GPI_0.....	69
2.7.15	Control Head Interface.....	70
2.7.16	Second Control Interface	70
2.8	Post Installation Check.....	71
2.8.1	Mechanical Installation and Wiring Check.....	71
2.8.2	Power Supply	71
2.8.3	Activated Subsystems.....	71
2.8.4	Receiver Operation	71
2.8.5	Antenna Check.....	71
2.8.6	Interference Check.....	71
2.8.7	Flight Test Check	72
2.9	Troubleshooting.....	72
2.10	Targets Status Protocol - IF3 Interface	73
2.10.1	Term Definition.....	73
2.10.2	Physical Layer.....	74
2.10.3	Communication Description	75
2.10.4	Recommended Receiver Operation.....	80
3	Operation	81
3.1	General.....	81
3.2	Device Description	81
3.3	Controls and Indications.....	82
3.3.1	User Interface - BD406	82
3.3.2	Symbols on the BD406 Display	83
3.3.3	User Interface - PBD406.....	84
3.3.4	Audio Notification	85
3.3.5	Warning and Failure Indications	86
3.3.6	Power Interrupt Indication	88
3.4	Operation Modes.....	88
3.5	Start-Up - BD406 with Control Head	89
3.6	Start-Up - BD406 without Control Head	90
3.6.1	Operation with other Controller	90
3.7	Start-Up - PBD406	90
3.8	Mission Mode	91
3.8.1	Terms and Definitions	91
3.8.2	Course Deviation Indicator (CDI) – Beacon/NavPoint detailed Menu	94
3.8.3	Course Deviation Indicator (CDI) – Beacon/NavPoint Course View	95
3.8.4	Mission Mode - Menu Structure	96
3.8.5	Operations from Beacons/NavPoints Details View.....	97
3.8.6	Operations from Beacons/NavPoints Menu View	101
3.8.7	Operations from Config Menu View	103
3.8.8	Operations from Beacon/NavPoint Course View	105
3.9	GPS Status View	106
3.10	Receive Operation – Message Detection.....	107
3.11	Contact Data.....	109
4	Index.....	112

List of Figures

Some figures in this manual are for basic understanding and can be different to the actual design.

Figure 1: BD406-(XX1)	16
Figure 2: BD406-(XX3)	16
Figure 3: PBD406-(XX1) - Portable device	16
Figure 4: Batty charger for PBD406	16
Figure 5: Menu Screens - Beacons Indication	18
Figure 6: Menu Screens - NavPoints Indication	18
Figure 7: Type plate (example)	36
Figure 8: BD406-(XX1) (front view)	38
Figure 9: Drilling Template -Rear-Panel Installation	38
Figure 10: BD406 without Control Head (front view)	38
Figure 11: MK4401	38
Figure 12: Drilling Template -Vehicle Installation	39
Figure 13: Dimensions - BD406 with Control Head	40
Figure 14: Dimensions - BD406 without Control Head	41
Figure 15: Dimensions - BD406 without Control Head with Mounting Kit MK4401	42
Figure 16: Dimensions - PBD406	43
Figure 17: Dimensions - Bracket for Vehicle Installation	44
Figure 18: BD406 – Connector Layout (rear side)	45
Figure 19: Connector Layout P1 - Digital and Analog I/O (rear side)	46
Figure 20: Connector Layout J1 - Serial Interfaces (rear side)	48
Figure 21: PBD406 – Connector Layout (front side)	51
Figure 22: PBD406 – Connector Layout (rear side)	51
Figure 23: PBD406 – Connector P3 (front side)	51
Figure 24: PBD406 – Connector P2 (front side)	52
Figure 25: Wiring - BD406 with Control Head, P1 Connector and Antennas	58
Figure 26: Wiring - BD406 with Control Head, J1 Connector (PBD406 J6 Connector)	59
Figure 27: Wiring - BD406 without Control Head, P1 Connector and Antennas	60
Figure 28: Wiring - BD406 without Control Head, J1 Connector	61
Figure 29: "PASSWORD"	62
Figure 30: "CH INFO"	63
Figure 31: "CM INFO"	63
Figure 32: Target Status Protocol - Packet Description	75
Figure 33: Target Status Protocol - Frame Description	76
Figure 34: User Interface - BD406*	82
Figure 35: LCD - View during Mission	83
Figure 36: LCD - Status Bar	83
Figure 37: User Interface - PBD406	84
Figure 38: Error/Warning - Display Description	86
Figure 39: Start-Up View	89
Figure 40: Error Messages	89
Figure 41: Operation - Clear Results	89
Figure 42: Mission Mode - CDI, Angular Definition for Fixed Position in Beacon/NavPoint detailed Menu	94
Figure 43: Mission Mode - CDI, Distance Definition for Fixed Position in Beacon/NavPoint detailed Menu	94
Figure 44: Mission Mode - CDI, Angular Mode, Definition for Constant Course (CRS) in Beacon/NavPoint Course View	95
Figure 45: Mission Mode - CDI, Distance Mode, Definition for Constant Course (CRS) in Beacon/NavPoint Course View	95
Figure 46: Mission Mode - Menu - Structure	96





List of Abbreviations

List of Abbreviations	
ARINC	Aeronautical Radio, Inc.
ASCII	American Standard Code for Information Interchange
bps	Bits per second
CBIT	Continuous Built-In Test
CDI	Course Deviation Indicator
CH	Control Head
CM	Chassis Module
COSPAS	Space System for the Search of Vessels in Distress (Russian words "Cosmicheskaya Sistyema Poiska Avaryynich Sudov")
CRC	Checksum Redundancy Check
DB	Database
DC	Direct Current
EET	Estimated Elapsed Time to the Target
ELT	Emergency Location Transmitter (aeronautical distress beacons)
EPIRB	Emergency Position Indicating Radio Beacon (maritime distress beacon)
ETA	Estimated Time of Arrival
etc.	et cetera
GND	Ground
GPI	General Purpose Input
GPO	General Purpose Output
GPS	Global Positioning System
HDPH	Headphone
I/O	Input/Output
ID	Identifier
MHz	Megahertz
MSG	Message
N/A, n/a	Not applicable
NM	Nautical Mile
NMEA	National Marine Electronics Association
NVG	Night Vision Goggles
PBIT	Power-On Built In Test
PC	Personal Computer
PDF	Protected Data Field
PLB	Personal Locator Beacon
RF	Radio Frequency
RS232	Recommended Standard 232
RS422	Recommended Standard 422
RTCA	Radio Technical Commission for Aeronautics Inc.
RX	Receive
SARSAT	Search and Rescue Satellite-Aided Tracking
SPKR	Speaker
SW	Software
TCXO	Temperature Compensated Crystal Oscillator
THD	Total Harmonic Distortion
TF	TufLok®, self-locking screws and threads
UTC	Coordinated Universal Time

Units

Units	
A	Ampere
mA	Milliampere
°C	Degree Celsius
cm	Centimeter
cd/m ²	Candela Per Square Meter (1 cd/m ² = 1 nit)
dBm	Power Ratio In Decibel referenced to 1 mW Leistungsverhältnis in Dezibel in Bezug auf 1 mW
dB	Decibel
g	Gram
kg	Kilogram
kHz	Kilohertz
km/h	Kilometer Per Hour
kts	Knots
MHz	Megahertz
Mbps	Mega Bits Per Second
mm	Millimeter
mph	Miles Per Hour (statute mile 1 mile = 1609,344 m)
Nm	Newton Meter
NM	Nautical Mile (1NM = 1852,0 m)
Ohm (Ω)	Resistance
s	Second
V	Volt
mV	Millivolt
W	Watt
mW	Milliwatt
"	Inch
°	Angular degree

General Safety Definitions

-  **DANGER** Indicates a hazardous situation which, if not prevented, will result in death or serious injury.
-  **WARNING** Indicates a hazardous situation which, if not prevented, could result in death or serious injury.
-  **CAUTION** Indicates a hazardous situation which, if not prevented, could result in minor or moderate injury.
-  **NOTICE** Is used to address practices not related to physical injury.
-  **SAFETY INSTRUCTIONS** Safety instructions (or equivalent) signs indicate specified safety-related instructions or procedures.

Disposal

⚠ CAUTION The packaging material is inflammable, by burning toxic fumes may develop.

This product contains materials that fall under the special disposal regulation. We recommend the disposal of such materials in accordance with the current environmental laws.

- Dispose circuit boards by a technical waste dump which is approved to take on e.g. electrolytic aluminium capacitors. Do under no circumstances dump the circuit boards with normal waste dump.

NOTICE

The symbol of the crossed out wheeled bin shows: DO NOT throw the battery in municipal waste.



Discharged and partly discharged batteries can still have enough energy to be dangerous. Information about where batteries can be disposed free of charge is available at your local authorities.

Warranty Conditions

⚠ CAUTION The device(s) may be installed on an aircraft only by an approved aeronautical company (e.g. Part 145) which shall also examine the installation.

Any change made by the user excludes any liability on our part (excluding the work described in this manual).

- The device must not be opened.
- Do not make any modifications to the device, except for those described in the manual.
- Make connections to the inputs, outputs and interfaces only in the manner described in the manual.
- Install the devices according to the instructions.
We cannot give any guarantee for other methods.

Conditions of Utilization

With this device you bought a product which was manufactured and tested before delivery with the utmost care.

Please take your time to read the instructions which you ought to follow closely during installation and operation.

Otherwise all claims under the warranty will become void and a decreased service life or even damages must be expected.

⚠ CAUTION The user is responsible for protective covers and/or additional safety measures i to prevent damages to persons and electric accidents.

Additional Conditions of Utilization

Please refer to "Safety-Conscious Utilization", page 21.

Non-Warranty Clause

We checked the contents of this publication for compliance with the associated hard and software. We can, however, not exclude discrepancies and do therefore not accept any liability for the exact compliance. The information in this publication is regularly checked, necessary corrections will be part of the subsequent publications.

Blank Page

1 General Description

In this chapter you can read about:

1.1	Introduction	14
1.2	Purpose of Equipment.....	15
1.3	Variants Overview	16
1.4	Scope of Functionality.....	17
1.4.1	Beacon / NavPoint Indication.....	18
1.4.2	Beacon / NavPoint Memory	18
1.4.3	Power Supply - BD406	19
1.4.4	Power Supply - PBD406	19
1.4.5	Audio Outputs	19
1.4.6	Illumination.....	19
1.4.7	Audio Notifications	19
1.4.8	Internal GPS Receiver	20
1.4.9	Built-In Tests	20
1.4.10	Installation Setup	20
1.4.11	Service Mode	20
1.5	Safety-Conscious Utilization	21
1.6	Cleaning and Disinfection of Devices	22
	Procedure:	22
1.7	Restriction for Use.....	22
1.8	Technical Data	23
1.8.1	Power Supply - BD406	23
1.8.2	Power Supply - PBD406	23
1.8.3	General Characteristics	24
1.8.3.1	Receiver Data.....	24
1.8.3.2	Internal GPS Receiver.....	24
1.8.3.3	GPS Antenna.....	25
1.8.3.4	Audio Subsystem.....	25
1.8.3.5	Interfaces.....	26
1.8.4	Dimensions & Weight - BD406	26
1.8.5	Dimensions & Weight - PBD406.....	26
1.8.6	Continued Airworthiness.....	27
1.8.7	Environmental Conditions.....	28
1.8.8	Certifications	29
1.9	Order Code	30
1.9.1	BD406, PBD406.....	30
1.9.2	Accessories.....	30
1.9.3	Spare Parts.....	31
1.9.4	Documentation.....	31

This manual describes the Becker Avionics COSPAS/SARSAT Beacon Decoder BD406 and PBD406 and its variants. The type plate on your device shows the part number for identification purposes (see "Type Plate", page 36).

Before starting operation of the device(s) please read this manual carefully, with particular attention to the description referring to your device(s).

Introduction

1.1 Introduction

The technical information in this document applies to the described product and variants of BD406-(XXX) and PBD406-(XXX).

- We also use the term BD406 or device, instead of BD406/PBD406 or instead writing the complete model number for descriptions.
- If a description refers to only one product variant is it specified.

The manuals "Maintenance and Repair" (M&R), "Installation and Operation (I&O) and "Operation Instructions" (OI) contain the sections:

Section	DV16401.04 M&R	DV16401.03 I&O	- OI
General	X	X	-
Installation	X	X	-
Operation	X	X	X
Theory of Operation	X	N/A	N/A
Maintenance and Repair	X	N/A	N/A
Illustrated Parts List	X	N/A	N/A
Modification and Changes	X	N/A	N/A
Circuit Diagrams	X	N/A	N/A
Certifications	X	N/A	N/A
Attachments	X	N/A	N/A

1.2 Purpose of Equipment

The COSPAS/SARSAT Beacon Decoder BD406 and PBD406 are made for use by search and rescue (SAR) authorities as a tool to receive vital information and assistance during rescue missions.

- The BD406 is a single block device made for installations in fixed and rotary wing aircraft.
- The PBD406 is a portable version of the BD406 with built-in battery and housing.
- BD406/PBD406 in SAR missions decrease the time necessary to locate a distress signal, which has a direct effect on the probability of survival of the person in distress at sea or on land.
- The BD406/PBD406 has direct detection of the distress messages transmitted on 406 MHz (ELTs for aviation use, EPIRBs for maritime use, and PLBs for personal use).
 - It decodes the position of the transmitted signal.
 - It shows the beacons relative position and does continuous tracking during the rescue mission.

The International Satellite System for Search and Rescue (COSPAS-SARSAT) system is described on www.cospas-sarsat.org.

Further details of the Cospas-Sarsat system as well as the address of the national supervisory authorities are obtainable from:

International Cospas-Sarsat Programme

700 de la Gauchetiere West, Suite 2450

Montreal, Quebec H3B 5M2

Canada

Tel: +1 514 954-6761

Fax: +1 514 954-6750

Email mail@cospas-sarsat.int

URL: www.cospas-sarsat.int

1.3 Variants Overview

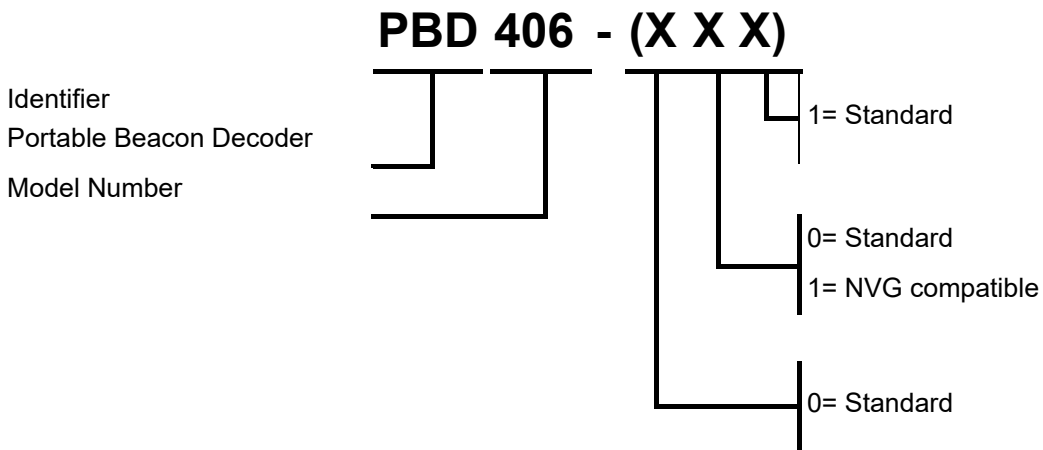
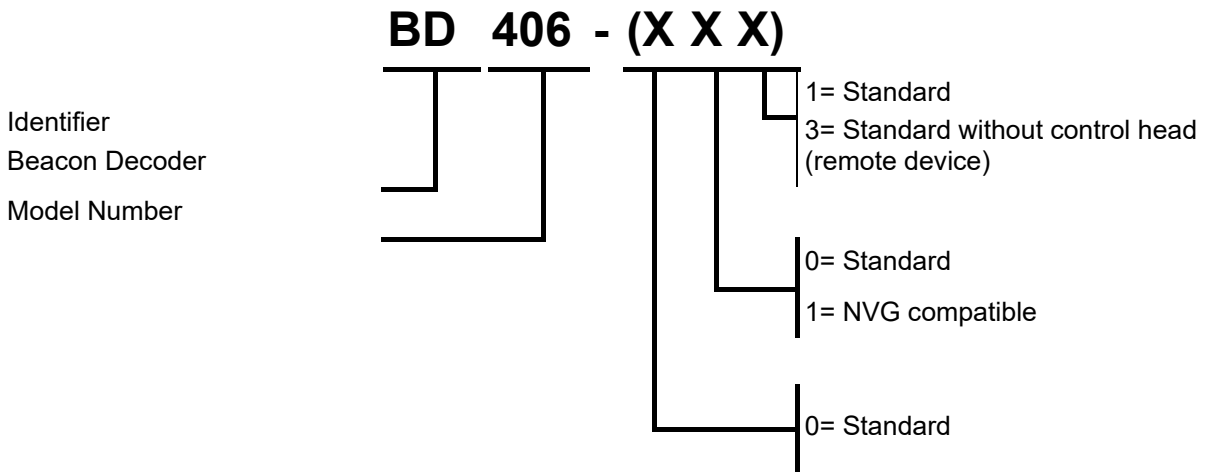

Figure 1: BD406-(XX1)

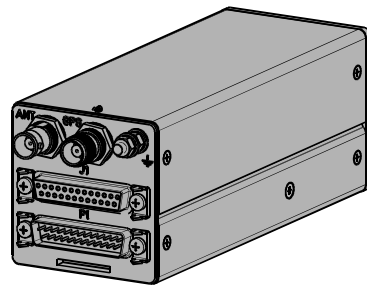

Figure 2: BD406-(XX3)



Figure 3: PBD406-(XX1) - Portable device

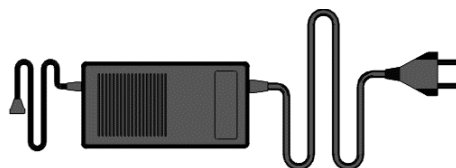

Figure 4: Batty charger for PBD406

1.4 Scope of Functionality

- The device(s) receives, decodes and processes COSPAS/SARSAT distress signal in a range of 406.020...406.081 MHz.

BD406 with control head:

- The BD406 with control head is a single block device made for installations in fixed and rotary wing aircraft.
- BD406 dimensions correspond to the standard instrument diameter of 58 mm (2¼ inch).
 - It can be installed with four screws (rear panel installation).
 - All controls and indicators are on the front panel.
 - The equipment connectors and the antenna sockets are at the rear of the device.

BD406 without control head:

- The BD406 without control head is a single block remote-controlled device made for installations in fixed and rotary wing aircraft.
 - It does not have a control head or user interface (remote-controlled).
 - The equipment connectors and the antenna sockets are at the rear side of the device.
- Installation: For dimension see "BD406 without Control Head" page 41 and "BD406 without Control Head with Mounting Kit MK4401" page 42.
 - Use the mounting kit MK4401 to install the device in the avionic bay environment.

PBD406:

- PBD406 is the portable version with its own battery, internal speaker, battery charger and inputs for RX and GPS antennas.
- It includes a BD406 single block device with control head.

1.4.1 Beacon / NavPoint Indication

BD406/PBD406 with control head:

In mission mode, which is the typical operational mode, the user has access to beacon views and NavPoint views. The beacon view is related to the set of data received from distress beacons during a mission.

The different data presentations of single beacon include:

- Raw 15HexID, processed data: (Protocol Type Standard/National Location, etc.), beacon type (EPIRB, PLB, etc.), beacon serial number, TAC (Type Approval Certificate Number), beacon position (if distress beacon has GPS functionality).
- Up to 49 received beacons can be stored in internal memory.
- Access through the rotary knob, and LEXCH / REXCH keys (details "Controls and Indications" page 82).
- Beacon data can be removed from memory on demand. Refer to section 3 for menu details.

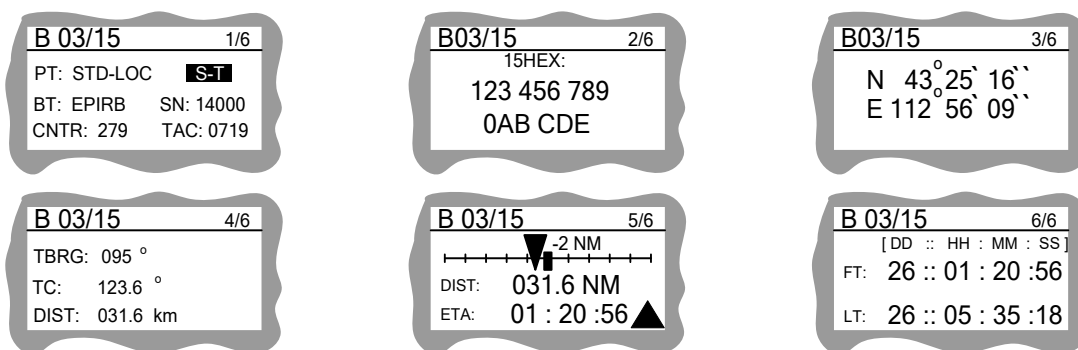

Figure 5: Menu Screens - Beacons Indication

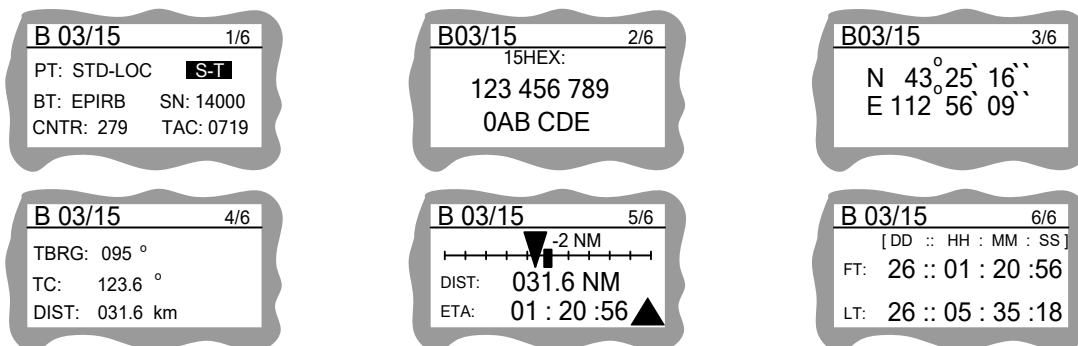

Figure 6: Menu Screens - NavPoints Indication

Navigational data from beacon can be used to create NavPoint.

NavPoint is a set of navigational data (latitude, longitude, name, additional info) that can be stored in internal memory (up to 49 records) and used to navigate to a selected target. Details see "Operation" page 81.

1.4.2 Beacon / NavPoint Memory

BD406/PBD406 with control head:

- The device(s) can store up to 49 beacons and 49 NavPoints in the internal nonvolatile memory.
- The beacon memory can be erased at start-up of the device (details "Start-Up - BD406" page 89, and "Mission Mode" page 91).

1.4.3 Power Supply - BD406

BD406 has an operational power range of 9...32 VDC but start-up (power-on) of the device requires 10.5...32V DC. Once the device is operational the power supply can be reduced to 9 VDC.

1.4.4 Power Supply - PBD406

PBD406 power is supplied from an internal 12.0 V maintenance-free rechargeable, sealed dry acid battery. The internal power module, installed inside the chassis, operate in a range of 9...36 VDC.

Estimated charge time for a depleted battery is approximately 8 hours. The charger can also be used as an external power supply; therefore there is no need to disconnect the charger when the battery is fully charged. The charger can be safely left plugged in. The nominal operating time on full battery charge is no less than 5 hours.

The battery is protected against a deep discharge – PBD406 will not operate/start when battery voltage is < 10.5 V.

The battery should be charged every six months for long term inactive storage periods of more than six months.

Notice: Operating time of PBD406 can decrease for ambient temperatures < 0 °C.

1.4.5 Audio Outputs

The receiver has two audio outputs: headphone and speaker.

Headphone rated output power: 300 mW into 150 Ω.

Speaker rated output power: 4 W into 4 Ω.

1.4.6 Illumination

BD406/PBD406 with control head:

The illumination of LCD and push buttons can be controlled internally from the front panel knob or externally via the dimming inputs.

With external dimming the illumination curve (brightness to voltage relation) can be adjusted in the installation setup.

For BD406-(011) / PBD406-(011) the illumination curve cannot be set.

In case of PBD406-(001) and PBD406-(011) - DIMMING INPUT must be set in installation setup in a range of 0...14 V (see "Dimming Input" page 65).

Notice: Illumination of BD406-(XX1) / PBD406-(XX1) is automatically off when the power supply voltage is below 10.5V.

1.4.7 Audio Notifications

BD406 have a voice notification system that informs the user about:

- Incoming COSPAS/SARSAT messages, homing – distance and bearing to the selected target (message is triggered on demand by rotary knob or related discrete input), the device failure. Details "Audio Notification" page 85.

1.4.8 Internal GPS Receiver

BD406 is equipped with an integrated GPS receiver module LEA-6S manufactured by u-blox. For details about the GPS receiver please see www.u-blox.com.

BD406-(XX1) / PBD406-(XX1) use GPS data in ASCII format (NMEA 0183 compliant) from the internal GPS receiver via RS232 interface. Details "IF2 - GPS Interface (external/internal)" page 55.

⚠ CAUTION

- Connect active GPS antenna to the BD406/PBD406 only when the device is **not** powered-on.
- Do not connect or disconnect the GPS antenna when the BD406/PBD406 operates, as the internal GPS receiver calibrates the noise floor on power-up.
- To connect the antenna after power-up can cause an extended acquisition time.
- Use **ONLY** active antennas according to specification see "GPS Antenna" page 25.
- Passive GPS antennas must not be connected.

1.4.9 Built-In Tests

BD406 with control head:

After power-on, the device starts a self-test (PBIT).

In case of errors the device notifies the user about any malfunction. During PBIT the receiver identifies itself and shows the software versions of the control head and chassis module.

During normal operation, a continuous built-in test (CBIT) verifies the correct operation of the device in background. In case of problems an error notification is shown, details see "Warning and Failure Indications" page 86.

BD406 without control head:

To control and read the test results and messages an external control interface is required. In case of problems, an error notification can be read out through the external control interface.

1.4.10 Installation Setup

BD406 with control head:

Configuration of the installation parameters such as headphone and speaker activation, GPS source, illumination level, and further parameters is possible in installation setup.

BD406 without control head:

Only manufacturer (on customer request) configures specific installation settings. Contact manufacturer to change current configuration when device is already delivered.

1.4.11 Service Mode

Special factory configuration of the system is possible in this mode through a RS422 interface with a proprietary serial data communication protocol. This mode is serviced by the manufacturer.

1.5 Safety-Conscious Utilization

⚠ CAUTION

The device(s) may be installed on an aircraft only by an approved aeronautical company (e.g. Part 145) which shall also examine the installation.

SAFETY INSTRUCTIONS

- The installation of the device into an aircraft may be carried out only by an authorized installation company. The country regulations always must be obeyed.
- Use the product only in the specified conditions, see "Technical Data", page 23.
- Power supply:
 - Do not connect the device to AC sources.
 - Make sure that the device is connected to the mandatory DC source, see "Technical Data", page 23.
 - Do not connect the device with reversed polarity to the DC source.
- Circuit breaker:
 - Use the applicable fuses in the power supply line for protection of the application, see "Technical Data", page 23.
- Use ONLY active antennas in the specified conditions, see "Technical Data", page 23.
- Do not connect passive GPS antennas to the GPS TNC input.
- Never short-circuit the PBD406 battery.
- Do not expose the PBD406 to temperatures > 50 °C for a longer time. Overheating of the device battery can cause a risk of bursting and explosion.
- Obey all additional safety instructions in this manual.

NOTICE

Excessive pulses on the DC bus of the aircraft may cause damage on electrical circuits of any installed instrument.

Do not turn on the device during engine start or shutdown.

1.6 Cleaning and Disinfection of Devices

Cleaning:

Within the framework of officially prescribed or recommended protective measures during the corona pandemic, it makes sense that devices and systems that are directly accessible to people, are disinfected as required. This particularly applies to the controls on avionics devices.

NOTICE

Not all commercially available cleaning agents/disinfectants are suitable for use on the surfaces of our devices. Many of the agents contain solvents or greasing components that can cause undesired effects on the controls and the display.

Example:

- Do not use aggressive cleaning agents e.g. Acetone.
 - These cleaning agents can cause damages.

Procedure:

NOTICE

- Do not clean/disinfect the device(s) during operation.

Device body and the controls:

- Clean the device body and the controls with a clean, soft, lint free cloth moistened with clean water.

Disinfection:

To reduce the risk of infection:

- As a disinfectant, we recommend diluted monohydric alcohols such as Isopropanol or Ethanol.
 - Wear suitable protective gloves that are disinfected.
 - Moisten a clean, soft, lint free cloth with the related liquid to clean all controls.
 - Please obey the usual protective measures when using monohydric alcohols for cleaning purposes.
- Do not use spray bottles or evaporators to apply disinfectants or cleaning liquids to the Becker Avionics devices. Liquids could penetrate the devices and can result in damage.

LCD screen:

- Clean the LCD screen with a clean, soft, lint free cloth moistened with clean water and take care not to scratch the surface.
- Cleaning agents suitable for cleaning TFT screens and LCD displays can also be used. Obey the related instructions from manufacturer.

1.7 Restriction for Use

SAFETY INSTRUCTIONS

The product is to be used inside the declared limits.

1.8 Technical Data

1.8.1 Power Supply - BD406

BD406	Specifications	
	BD406 with control head	BD406 without control head
Nominal supply voltage	9...32 VDC (Start-up voltage 10.5...32 VDC)	
Power consumption	Power off state: ≤ 150 µA @ 32 VDC	Power off state: ≤ 150 µA @ 32 VDC
Max. power consumption	≤ 1200 mA @ 9V	
Normal operation		
	LCD with white backlight: Speaker enabled with 4 Ω load, headphones enabled with 150 Ω load, no audio. ≤ 320 mA @ 9 VDC (Backlight off) ≤ 320 mA @ 14 VDC (Backlight on 100%) ≤ 160 mA @ 32 VDC (Backlight on 100%)	Device without control head: ≤ 270 mA @ 9 VDC ≤ 200 mA @ 14 VDC ≤ 110 mA @ 32 VDC
	LCD with NVG compliant backlight: Backlight on 100%, speaker enabled with 4 Ω load, headphones enabled with 150 Ω load, no audio. ≤ 320 mA @ 9 VDC ≤ 260 mA @ 14 VDC ≤ 130 mA @ 32 VDC	n/a
Dimming control	14 VDC or 28 VDC	n/a

1.8.2 Power Supply - PBD406

PBD406	Specifications
Nominal external supply voltage	9...36 VDC
Battery voltage - nominal	12 VDC
Battery type	Sealed Lead Acid
Charging time	8 h, the charger can be left plugged in to the device
Battery operating time	≥ 5 h (speaker output disabled, headphone output enabled for load 150 Ω. Backlight disabled, beacon message received each 50 s)

Technical Data

1.8.3 General Characteristics

BD406 / PBD406	Specifications
Frequency range	406.020...406.081 MHz
Temperature compensated VCO long term stability	≤ ± 5 ppm after 10 years BD406: at temperature range -40...+85 °C PBD406: at temperature range -15...+50 °C
Display	Graphic 128x64 dots - LCD, white or NVG compatible backlight
Storage temperature	BD406: -55...+85 °C PBD406: -15...+50 °C
Operating temperature (as per RTCA DO-160E)	BD406 with control head: -15...+55 °C (short-time -40...+70 °C) BD406 without control head: -15...+55 °C (short-time +70 °C) PBD406: -15...+50 °C
Operating altitude (as per RTCA DO-160E)	BD406: 15 000 ft PBD406: n/a
Vibration (as per RTCA DO-160E)	BD406: Fixed wing Category S (Curve M) Rotary wing Category U (Curve G) PBD406: n/a

1.8.3.1 Receiver Data

BD406 / PBD406	Specifications
COSPAS/SARSAT analysis	Reception, analysis, correction of COSPAS/SARSAT data signal
Modulation (data encoding)	Biphase L-phase +1.1 / -1.1 rad
Bit rate	400 bps ± 1%
Digital messages	Short Message 112 bit Long Message 144 bit
Sensitivity	-104...0 dBm @ 50 Ω
Dynamic range	-104...0 dBm
Nominal impedance of antenna input	50 Ω
Absolute max. input power at antenna input	+30 dBm

1.8.3.2 Internal GPS Receiver

BD406 / PBD406	Specifications
GPS receiver type	uBlox LEA-6S

1.8.3.3 GPS Antenna

BD406 / PBD406	Specifications
Antenna type	Active
Minimum gain	15 dB
Maximum gain	50 dB
Maximum noise	1.5 dB
Nominal supply voltage	2.75...3.4 VDC
Maximal supply current	50 mA

1.8.3.4 Audio Subsystem

BD406	Specifications		
	BD406 with control head / PBD406	BD406 without control head	
Rated output for speaker operation	≥ 4 W into 4 Ω	Factory default audio is disabled Enabled on request in configuration	
Rated output power for headphone operation	≥ 300 mW into 150 Ω ≥ 100 mW into 600 Ω		
Audio frequency response			
Relative to 1000 Hz @ 4 Ω load for speaker operation	+1 dB/-3 dB in the frequency range of 350...4000 Hz		
Relative to 1000 Hz for headphone operation	+1 dB/-3 dB in the frequency range of 350...4000 Hz		
THD+N	Headphone output		≤ 10%
	Speaker output		≤ 4%

Technical Data

1.8.3.5 Interfaces

BD406	Specifications	
	BD406 with control head / PBD406	BD406 without control head
Serial interfaces	RS422 – for service purposes	n/a
	RS422 – auxiliary port (for future use)	n/a
	RS232 – GPS external/internal data transmission NMEA 0183 compliant	n/a
	RS232 – Targets Status Protocol	RS232 – Targets Status Protocol Baud rate : 19 200 Data bits: 8 Parity: none Stop bits: 1
	ARINC 429 output label 162 (ADF bearing)	n/a

1.8.4 Dimensions & Weight - BD406

BD406	Specifications	
	BD406 with control head / PBD406	BD406 without control head
Front panel HxW	61 x 61 x mm (2.4 x 2.4 in)	
Device depth complete	230 mm (9 in)	190 mm (7.5 in)
Mounting depth	208.5 mm (7.5 in)	236 mm (9.29 in) with mounting kit MK4401
Installation method	Rear panel 4x screws at front panel Ø 58 mm (2¼ inch)	Avionic bay environment 2x Phillips head screw M4x8 at the front plate for mounting in MK4401
Weight	≤ 700 g	≤ 600 g + ≤ 130 g (mounting kit MK4401)
Material of Case / Surface treatment	AlMg / control head coated with black matt paint	AlMg

1.8.5 Dimensions & Weight - PBD406

PBD406	Specifications
Front panel HxW	83 x 174 mm (3.3 x 6.7 in)
Device depth complete	334 mm (13.1 in) with handle in maximal position
Installation method	Portable device
Weight	≤ 3700 g

1.8.6 Continued Airworthiness

A regular maintenance of this device(s) is not necessary:

- The maintenance is specified as "on condition" only.
- It is recommended to do a check of the frequency accuracy of the local frequency reference after 10 years.

Technical Data

1.8.7 Environmental Conditions

The tests were done in accordance with RTCA DO-160E under consideration of the recorded environmental categories and conditions:

Environmental Condition	Section	Cat.	Remarks
Temperature and Altitude	4	A1	
Ground Survival Low Temperature	4.5.1	A1	-55 °C
Short-Time Operating Low Temperature	4.5.1	A1	-40 °C
Operating Low Temperature	4.5.2	A1	-15 °C
Ground Survival High Temperature	4.5.3	A1	+85 °C
Short-Time Operating High Temperature	4.5.3	A1	+70 °C
Operating High Temperature	4.5.4	A1	+55 °C
In-flight Loss of Cooling	4.5.5	X	No forced cooling required
Altitude	4.6.1	A1	15 000 ft
Decompression	4.6.2	A1	n/a
Overpressure	4.6.3	A1	n/a
Temperature Variation	5	X	n/a
Humidity	6	X	n/a
Shock and Crash Safety	7	A	Fixed wing and helicopter, standard
Vibration	8	S+U	Test curve M+G fixed wing + helicopter
Explosion Atmosphere	9	X	n/a
Waterproofness	10	X	n/a
Fluids Susceptibility	11	X	n/a
Sand and Dust	12	X	n/a
Fungus Resistance	13	X	n/a
Salt Fog	14	X	n/a
Magnetic Effect	15	Z	1° deflection at 0.3 m
Power Input	16	B	DC installations with battery of significant capacity
Voltage Spike	17	X	n/a
Audio Freq. Conducted Susceptibility	18	X	n/a
Induced Signal Susceptibility	19	X	n/a
Radio Frequency Susceptibility	20	X	n/a
Emission of Radio Frequency Energy	21	B	Equipment where interference should be controlled to a tolerable level
Lightning Induced Transients Susceptibility	22	X	n/a
Lightning Direct Effects	23	X	n/a
Icing	24	X	n/a
Electrostatic Discharge (ESD)	25	A	Equipment operated in an aerospace environment
Fire, Flammability	26	X	n/a

1.8.8 Certifications

**SAFETY
INSTRUCTIONS**

Unauthorized changes or modifications to the device(s) can void the compliance to the required regulatory agencies and authorization for continued equipment usage.

Order Code

1.9 Order Code**1.9.1 BD406, PBD406**

Qty	Device	
1	BD406-(001), Single Block, 2¼ inch Beacon Decoder	Article-No. 0619.760-924
1	BD406-(011), Single Block, 2¼ inch Beacon Decoder, NVG compatible	Article-No. 0619.787-924
1	BD406-(003), Single Block, Beacon Decoder, remote-controlled device without control head	Article-No. 0670.960-924
1	PBD406-(001), Portable Single Block Beacon Decoder	Article-No. 0619.809-924
1	PBD406-(011), Portable Single Block Beacon Decoder, NVG compatible	Article-No. 0619.825-924

1.9.2 Accessories

Qty	Mounting Kit for BD406 without control head	
1	Mounting kit MK4401	Article-No. 0556.726-284

Qty	Connector Kit CK406-C	
1	CK406-C Connector Kit (crimp version): <ul style="list-style-type: none"> • 1x 25-pol. cable connector, crimp F • 1x 25-pol. cable connector, crimp M • 2x Connector housing for 25-pol. cable connector • 1x BNC antenna plug • 1x TNC antenna plug 	Article-No. 0629.545-954
1	25-pol. cable connector, crimp F	Article-No. 0472.921-277
1	25-pol. cable connector, crimp M	Article-No. 0891.551-277
1	Connector housing for 25-pol. cable connector	Article-No. 0775.479-277
1	BNC antenna plug	Article-No. 0725.706-277
1	TNC antenna plug*	Article-No. 0551.731-277

*Notice: Use this plug only with RG223/U cable.

Qty	Connector Kit CK406-S	
1	CK406-S Connector Kit (soldering version): <ul style="list-style-type: none"> • 1x 25-pol. cable connector, soldering F • 1x 25-pol. cable connector, soldering M • 2x Connector housing for 25-pol. cable connector • 1x BNC antenna plug • 1x TNC antenna plug 	Article-No. 0629.553-954
1	25-pol. cable connector, soldering F	Article-No. 0725.021-277
1	25-pol. cable connector, soldering M	Article-No. 0726.311-277
1	Connector housing for 25-pol. cable connector	Article-No. 0775.479-277
1	BNC antenna plug	Article-No. 0725.706-277
1	TNC antenna plug	Article-No. 0552.781-277

Qty	Antennas for BD406	
1	406MHz antenna	Article-No. 0629.634-952
1	GPS antenna 4G15A-XB-1 white	Article-No. 0629.731-952
1	GPS antenna 4G15A-XB-3 green	Article-No. 0629.741-952

Qty	Antennas for PBD406	
1	406MHz antenna	Article-No. 0629.618-952
1	406MHz antenna cable, coaxial	Article-No. 0629.642-950
1	GPS antenna	Article-No. 0629.626-952

Qty	Mounting, carry equipment	
1	Vehicle mounting bracket	Article-No. 0549.940-262
1	Carrying handle	Article-No. 0624.160-252
1	Carrying bag and shoulder strap	Article-No. 0636.258-959

Qty	BT406 Beacon Decoder Test Set	
1	BT406 Beacon Decoder Test Set - for final test procedure and post-repair maintenance. N/A for BD406 without control head (remote controlled device)	Article-No. 0621.481-914

1.9.3 Spare Parts

Qty	Battery	
1	Accumulator 12 V / 2 Ah	Article-No. 0883.158-391

Qty	Power supply + AC cable	Article-No. 0889.113-918
1	Power supply	Article-No. 0530.158-918
1	AC-connector cable	Article-No. 0295.728-276

1.9.4 Documentation

Qty	Documentation	
1	(OI) BD406/PBD406 Operating Instructions, English	Article-No. 0629.324-071
1	(I&O) BD406/PBD406 Installation and Operation manual, English	Article-No. 0629.294-071
1	(M&R) BD406/PBD406 Maintenance and Repair manual, English	Article-No. 0629.308-071

Blank Page

2 Installation

This manual must be available during performance of all tasks.

The installation of the device(s) depends on the device, the aircraft and its equipment and therefore only general information can be given in this section.

Any deviations from the instructions in this document are under own responsibility.

In this chapter you can read about:

2.1	Packaging, Transport, Storage	34
2.2	Device Assignment	35
2.2.1	Scope of Delivery	35
2.2.2	State of Delivery	35
2.2.3	Additional Equipment	35
2.2.4	Type Plate	36
2.2.5	Software/Firmware Status – Functionality	36
2.3	Installation Requirements	37
2.3.1	Rear Panel Installation - BD406 with Control Head	38
2.3.2	Avionic Bay Installation - BD406 without Control Head	38
2.3.3	Installation - PBD406	39
2.3.3.1	Installation in a Vehicle	39
2.4	Dimensions	40
2.4.1	BD406 with Control Head	40
2.4.2	BD406 without Control Head	41
2.4.3	BD406 without Control Head with Mounting Kit MK4401	42
2.4.4	PBD406	43
2.4.5	Bracket for Vehicle Installation	44
2.5	Electrical Interface	45
2.5.1	Connector Pin Assignments - BD406	45
2.5.1.1	406 MHz Antenna Connector (ANT)	45
2.5.1.2	GPS Antenna Connector (GPS)	45
2.5.1.3	Grounding Bolt	45
2.5.1.4	Device Connector P1 - Digital and Analog I/Os	46
2.5.1.5	Device Connector J1 - Serial Interfaces	48
2.5.2	Connector Pin Assignments - PBD406	51
2.5.2.1	406 MHz Antenna Connector (ANT)	51
2.5.2.2	GPS Antenna Connector (GPS)	51
2.5.2.3	External DC Voltage (DC IN)	51
2.5.2.4	Headphone / Speaker Output (HDPH)	52
2.5.2.5	Device Connector J6	52
2.5.3	Inputs / Outputs	52
2.5.3.1	Speaker Connection	52
2.5.3.2	Headphone Connection	53
2.5.3.3	Panel Illumination	53
2.5.3.4	/PWR_EVAL	53
2.5.3.5	/MSG	53
2.5.3.6	/GPO_0	53
2.5.3.7	/GPO_1	54
2.5.3.8	/GPI_0	54
2.5.3.9	/GPI_1, /GPI_2	54
2.5.3.10	/ON	54
2.5.3.11	/SDI_9, SDI_10	54
2.5.3.12	/GPI_CH	54
2.5.3.13	IF0 - ARINC Output	55
2.5.3.14	IF1 - Service Protocol Interface	55
2.5.3.15	IF2 - GPS Interface (external/internal)	55
2.5.3.16	IF3 – Transmitter of Targets Status Protocol	56
2.5.3.17	IF3 - Receiver	56
2.5.3.18	IF4 - General Purpose Interface	56
2.6	Aircraft Wiring	57
2.6.1	Electrical Bonding and Grounding	57
2.6.2	Wiring - BD406 with Control Head, P1 Connector and Antennas	58
2.6.3	Wiring - BD406 with Control Head, J1 Connector (PBD406 J6 Connector)	59
2.6.4	Wiring - BD406 without Control Head, P1 Connector and Antennas	60

Packaging, Transport, Storage

2.6.5	Wiring - BD406 without Control Head, J1 Connector	61
2.6.6	Antenna Installation.....	62
2.7	Installation Setup	62
2.7.1	Start Installation Setup	62
2.7.1.1	Navigate between Pages.....	63
2.7.1.2	Store Setup Data	63
2.7.1.3	Cancel the Installation Setup	63
2.7.2	Device Info	63
2.7.3	General Configuration	64
2.7.4	Audio Warnings.....	65
2.7.5	Dimming Input.....	65
2.7.6	Brightness	66
2.7.7	Illumination Curve	66
2.7.8	Load Default.....	67
2.7.9	GPS Source Selection	68
2.7.10	External GPS Receiver Configuration.....	68
2.7.11	Target Status Protocol	68
2.7.12	ARINC 429	69
2.7.13	GPO_0	69
2.7.14	GPI_0	69
2.7.15	Control Head Interface.....	70
2.7.16	Second Control Interface	70
2.8	Post Installation Check.....	71
2.8.1	Mechanical Installation and Wiring Check.....	71
2.8.2	Power Supply	71
2.8.3	Activated Subsystems.....	71
2.8.4	Receiver Operation	71
2.8.5	Antenna Check.....	71
2.8.6	Interference Check.....	71
2.8.7	Flight Test Check	72
2.9	Troubleshooting.....	72
2.10	Targets Status Protocol - IF3 Interface	73

2.1 Packaging, Transport, Storage

Visually inspect the package contents for signs of transport damage.

⚠ CAUTION The packaging material is inflammable by burning, toxic fumes may develop.

Keep the packaging material and use it in the case of a return shipment. Improper or faulty packaging may lead to transport damages.

Make sure to transport the device always in a safe manner and with the aid of suitable lifting equipment if necessary. Do never use the electric connections for lifting. Before the transport, a clean, level surface should be prepared to put the device on. The electric connections may not be damaged when placing the device.

First Device Checkup

- Do a check for signs of damages.
- Please make sure that the indications on the type plate agree with your purchase order.
- Make sure that the equipment is complete ("Scope of Delivery", page 35).

Storage

If you do not install the device immediately, make sure to store it in a dry and clean environment. Make sure that the device is not stored near strong heat sources and that no metal chippings can get into the device.

Storage temperature see "Technical Data" page 23.

**SAFETY
INSTRUCTIONS**

PBD406: The batteries have a self-discharging of approx. 1% per day. We recommend to recharge the batteries every 3 month. Use delivered power supply+cable.

2.2 Device Assignment

This manual is valid for the devices:

- BD406-(001) + accessories.
- BD406-(011) + accessories.
- BD406-(003) + accessories.
- PBD406-(001) + accessories.
- PBD406-(011) + accessories.

2.2.1 Scope of Delivery

- Manuals
 - Operating Instructions.
- Device as ordered.

2.2.2 State of Delivery

- The device(s) are ready for use with factory default adjustments.
- Portable version PBD406 is delivered as a ready to use device with charged battery (it is recommended to connect the battery charger before first use).

2.2.3 Additional Equipment

- Installation material.
- Connector kits.
- Cable harness.
- Antenna.
- External control device for remote controlled BD406

"Accessories" page 30.

2.2.4 Type Plate

The device type is specified by the type plate (on the housing):

Example:

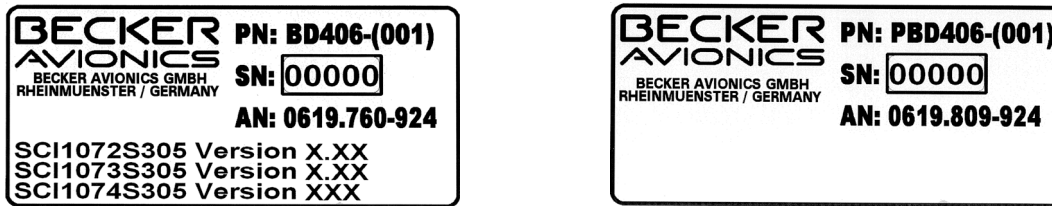

Figure 7: Type plate (example)

Explanation:

PN:	Type designation: BD406 = Single block device PBD406 = Portable device with power supply and accessories Options: -(001): Standard with control head -(003): Standard without control head -(011): NVG compatible
SN:	Unique number of the device
AN:	Article number
	Software: Refer to the version on the device type plate

2.2.5 Software/Firmware Status – Functionality

- The software version and program version of new deliveries are subjects to change without notice.

2.3 Installation Requirements

The installation of the device(s) depends on the device, the type of aircraft and its equipment and therefore only general information can be given in this section.

- The BD406 is a single block device made for installations in fixed and rotary wing aircraft.
- The PBD406 is a portable version of the BD406 with built-in battery and housing.

SAFETY INSTRUCTIONS

- Please use the device(s) only inside the declared limits see "Technical Data", page 23 and obey the regulations/notices described in this manual.
- The equipment is not qualified for installation in areas with fluid contamination.
- The device(s) must not be opened.
- Changes or modifications made to the device(s) not expressly approved in written form by Becker may void the authorization to operate this equipment.

BD406:

The installation of BD406 into an aircraft may be carried out by an authorized installation company. The country regulations always must be obeyed.

- Keep enough distance to devices with integrated ventilator fans to make sure the free circulation of the cooling air.
- The installation area must have a minimum distance of 30 cm from the magnetic aircraft compass, to prevent any interference to the magnetic compass.
- Forced cooling is not required.

PBD406:

- PBD406 is a portable device with its own power supply and external accessories.
- The device can be mounted in a vehicle.

SAFETY INSTRUCTIONS

- BD406 with control head is made for installation in cockpit environment of fixed and rotary wing aircraft.
- BD406 without control head is made for installation in avionics bay environment of fixed and rotary wing aircraft. Use the related mounting kit MK4401 for installation.

The installation must be in accordance with the local aviation authority approved guidelines. The installation must be in accordance with the standards applicable for the specified type or class of aircraft.

SAFETY INSTRUCTIONS

- Use only cables which are qualified for aircraft use (self-extinguishing).
- Interface lines TX-A/TX-B and RX-A/RX-B are each to be laid as 2-core twisted and shielded cables.
- Fit sleeves over the solder joints on the equipment connector.
- HF cable should not be included in the cable harnesses.
- Use the applicable fuses in the power supply line for the protection of the application, see "Technical Data", page 23.

⚠ CAUTION

- Examine the wiring carefully before power up the device(s) and examine particularly correct connection of the power supply lines.

Installation Requirements

2.3.1 Rear Panel Installation - BD406 with Control Head

- The BD406 with control head is made for rear panel installation.
- The four screws for installation are included with the delivery.
- Keep a minimum of 5 mm between the BD406 and other avionics for air circulation.
- More information please see: Dimensions, "BD406 with Control Head" page 40.



Figure 8: BD406-(XX1) (front view)

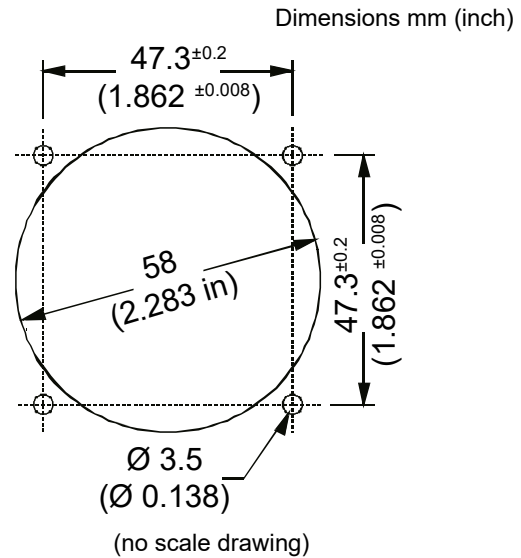

Figure 9: Drilling Template -Rear-Panel Installation

2.3.2 Avionic Bay Installation - BD406 without Control Head

- The BD406 without control head and mounting kit MK4401 are for avionic bay installation.
- Keep a minimum of 5 mm between the device and other avionics for air circulation.

Order of Installation

- Install MK4401 mounting frame in avionic bay environment, using three countersunk screws.
- Remove the two screws from device front plate. Loosen the securing-plate on mounting frame.
- Slide the device into the mounting.
- Push the security-plate into the locking slot and tighten the securing-plate. Tighten the device with the two screws from device front plate.
- Dimensions see, "BD406 without Control Head" page 41, "BD406 without Control Head with Mounting Kit MK4401" page 42.

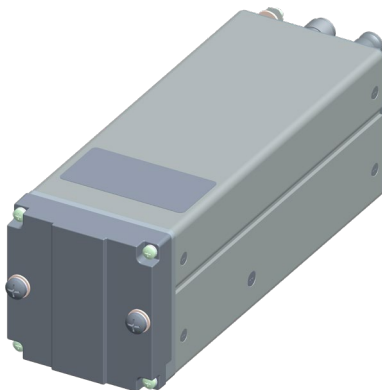

Figure 10: BD406 without Control Head (front view)

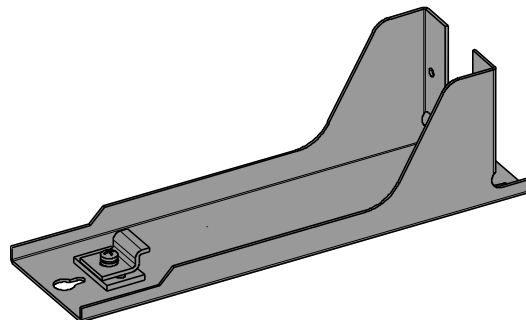

Figure 11: MK4401

2.3.3 Installation - PBD406

PBD406 is a portable device with case and mounting bracket.

- There is no special requirement for installation.
- The device can be installed in a vehicle. The related bracket is already installed.

2.3.3.1 Installation in a Vehicle

- Please use the installed bracket (bottom) for installation.
- Remove handle.
- Make sure to find a suitable spot to place the three bolts.
Details see: Dimensions, "Bracket for Vehicle Installation" page 44.
- Please check easy access to the user interface.
- Connect all required cables to the related sockets at front panel and to the socket at rear plate, details see "Connector Pin Assignments - PBD406" page 51.

Dimensions mm (inch)

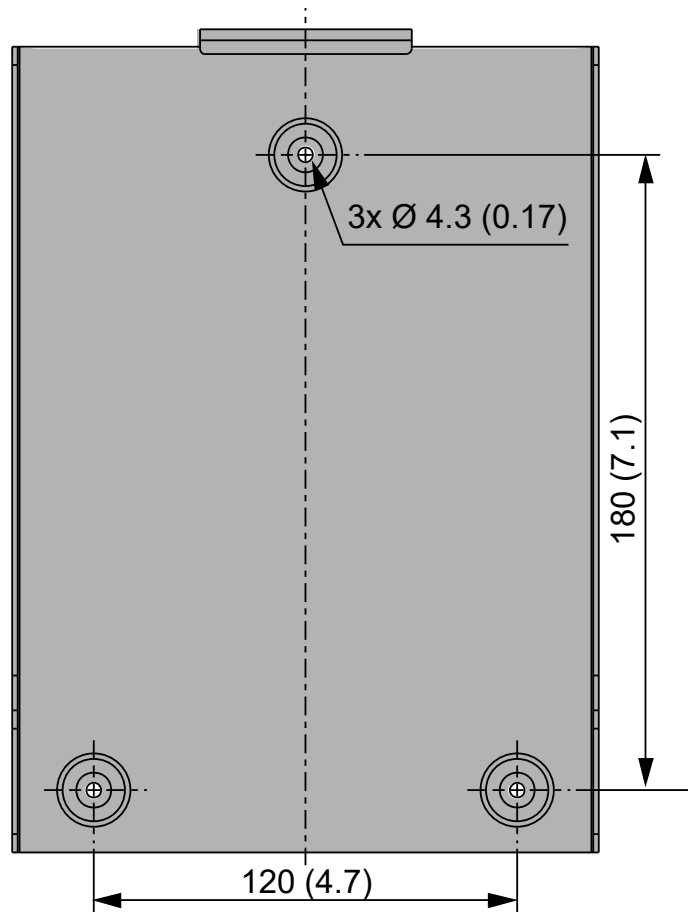

(no scale drawing)

Figure 12: Drilling Template -Vehicle Installation

2.4 Dimensions

2.4.1 BD406 with Control Head

Dimensions mm (inch)

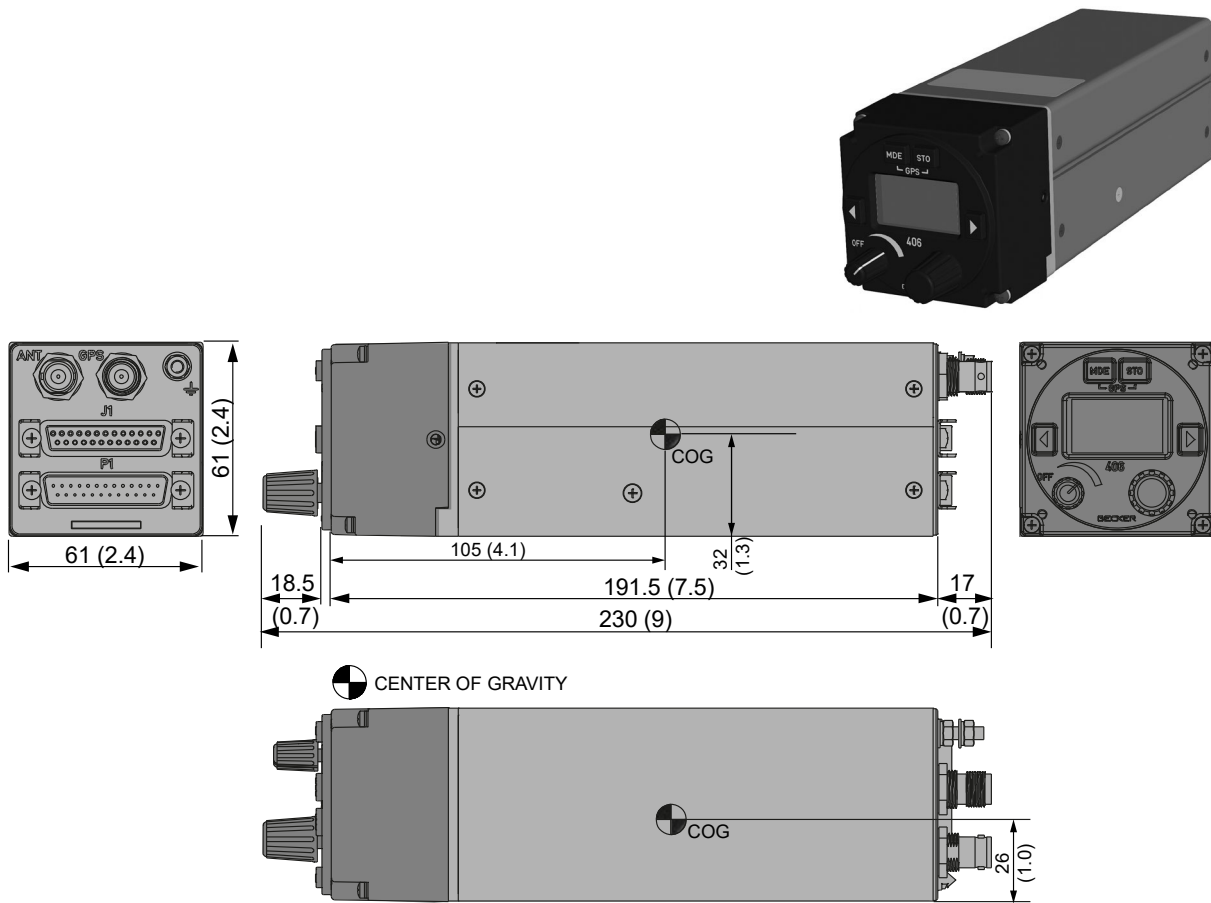

Figure 13: Dimensions - BD406 with Control Head

NOTICE

"Center of Gravity" for BD406

Tolerance: ± 5 mm.

Permitted deviation for dimensions without tolerances: DIN ISO 2768 T1 C (dimensions in mm)		
xx...6 (±0.3)	>30...120 (±0.8)	>400...1000 (±2.0)
>6...30 (±0.5)	>120...400 (±1.2)	>1000...2000 (±3.0)

2.4.2 BD406 without Control Head

Dimensions mm (inch)

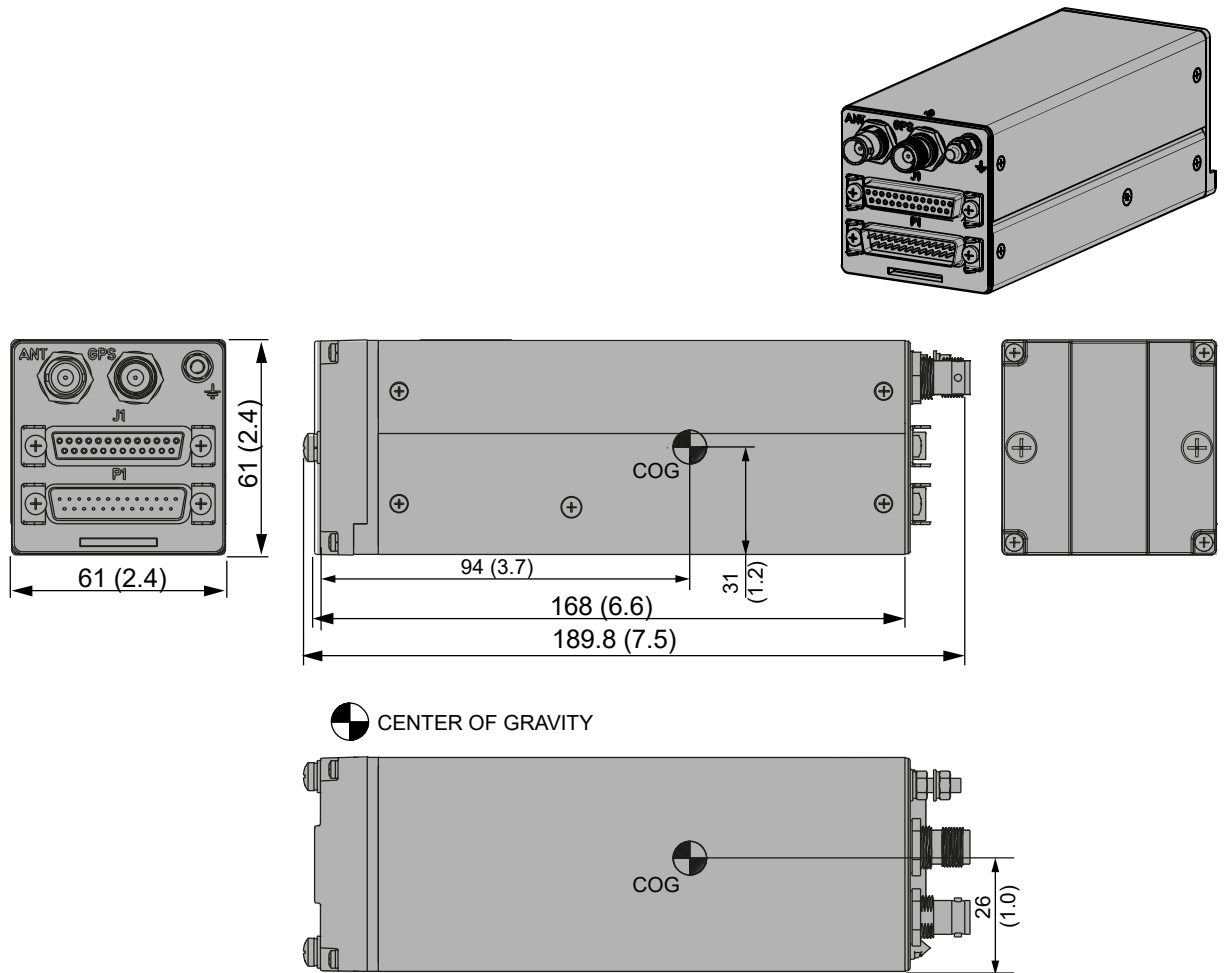

Figure 14: Dimensions - BD406 without Control Head

NOTICE "Center of Gravity" for BD406
Tolerance: ± 5 mm.

Permitted deviation for dimensions without tolerances: DIN ISO 2768 T1 C (dimensions in mm)		
xx...6 (±0.3)	>30...120 (±0.8)	>400...1000 (±2.0)
>6...30 (±0.5)	>120...400 (±1.2)	>1000...2000 (±3.0)

Dimensions

2.4.3 BD406 without Control Head with Mounting Kit MK4401

Dimensions mm (inch)

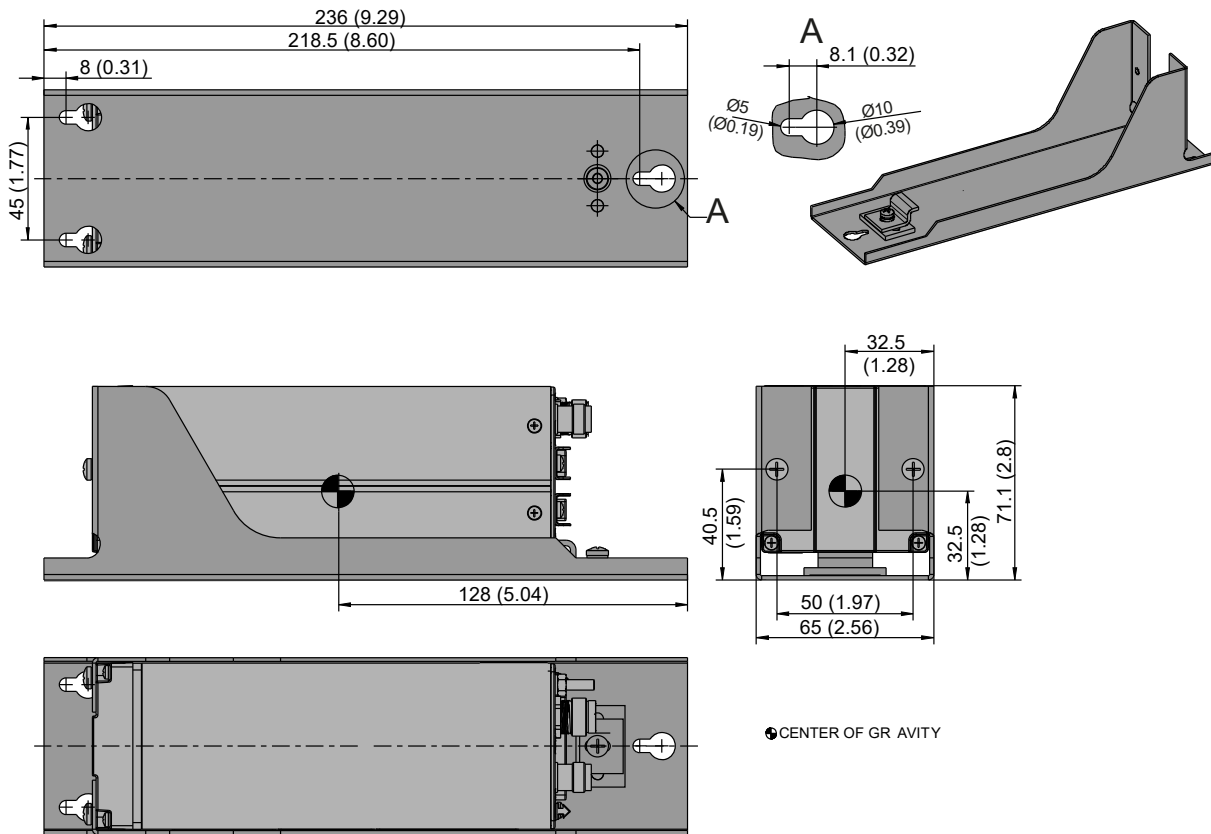

Figure 15: Dimensions - BD406 without Control Head with Mounting Kit MK4401

NOTICE

"Center of Gravity" for BD406 with mounting kit MK4401.

Tolerance: ± 5 mm.

Permitted deviation for dimensions without tolerances: DIN ISO 2768 T1 C (dimensions in mm)		
xx...6 (± 0.3)	>30...120 (± 0.8)	>400...1000 (± 2.0)
>6...30 (± 0.5)	>120...400 (± 1.2)	>1000...2000 (± 3.0)

2.4.4 PBD406

Dimensions mm (inch)

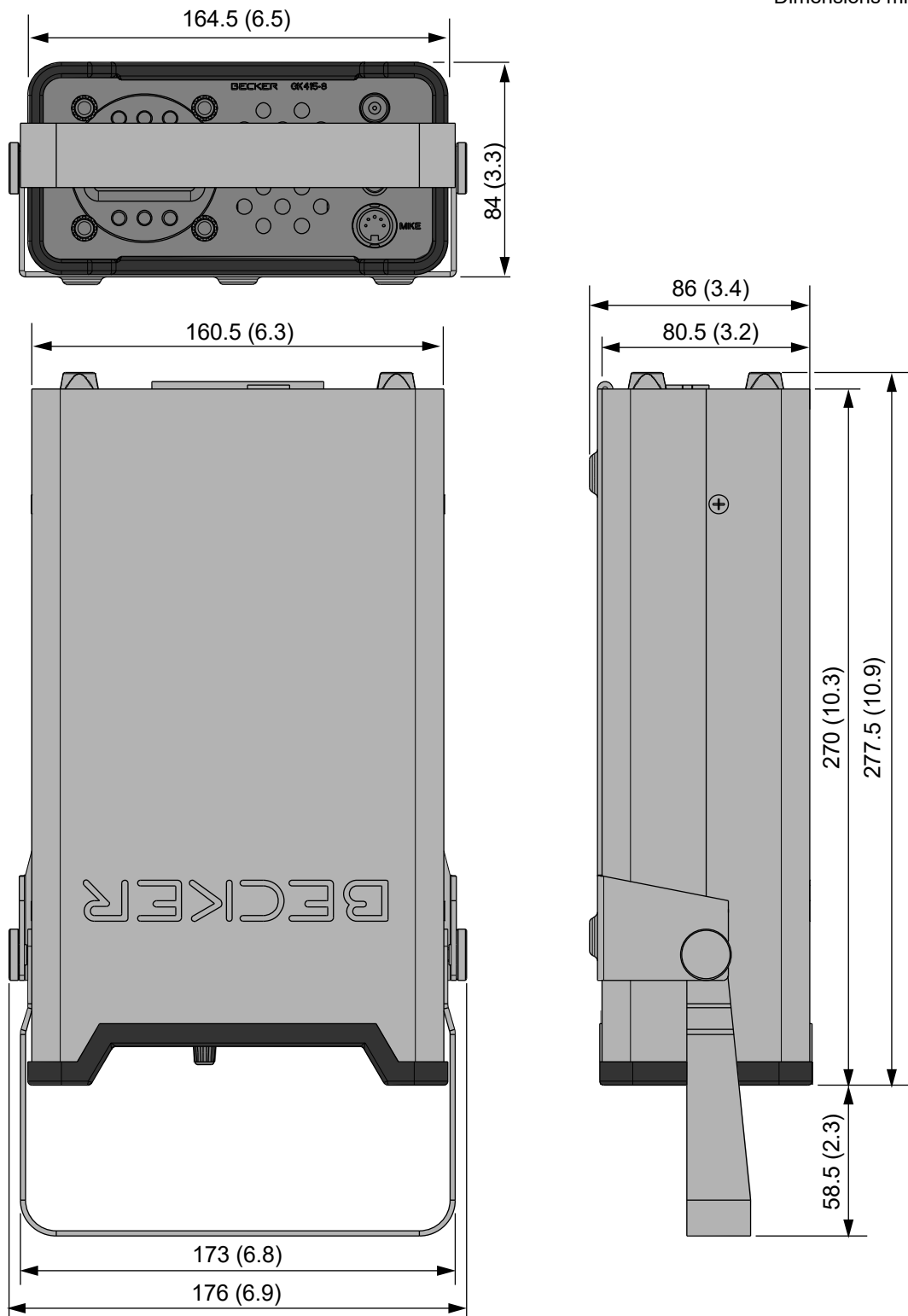

Figure 16: Dimensions - PBD406

Permitted deviation for dimensions without tolerances: DIN ISO 2768 T1 C (dimensions in mm)		
xx...6 (±0.3)	>30...120 (±0.8)	>400...1000 (±2.0)
>6...30 (±0.5)	>120...400 (±1.2)	>1000...2000 (±3.0)

Dimensions

2.4.5 Bracket for Vehicle Installation

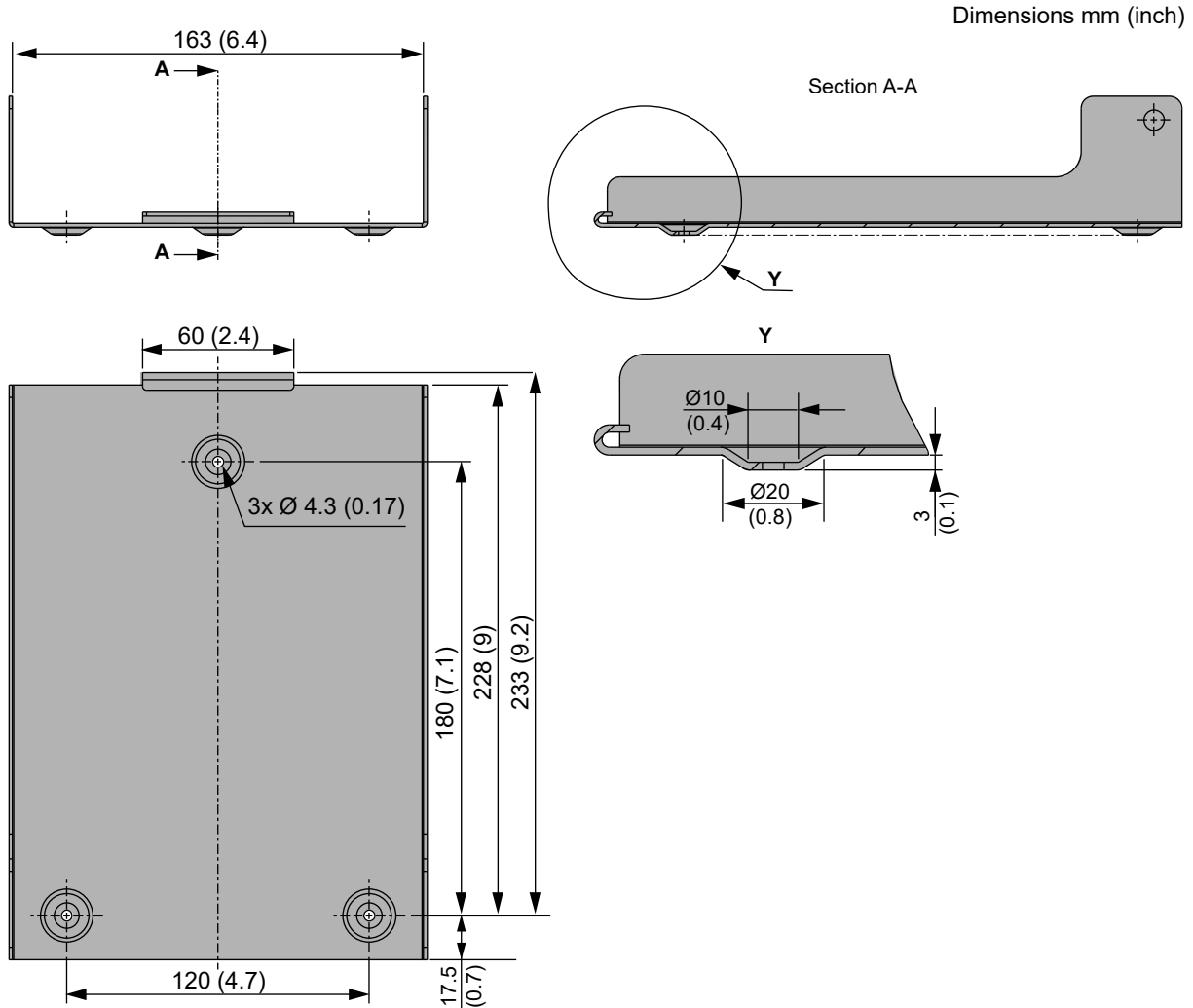
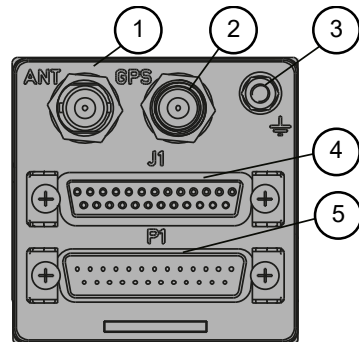

Figure 17: Dimensions - Bracket for Vehicle Installation

Permitted deviation for dimensions without tolerances: DIN ISO 2768 T1 C (dimensions in mm)		
xx...6 (±0.3)	>30...120 (±0.8)	>400...1000 (±2.0)
>6...30 (±0.5)	>120...400 (±1.2)	>1000...2000 (±3.0)

2.5 Electrical Interface

2.5.1 Connector Pin Assignments - BD406



- 1: 406 MHz antenna connector
- 2: GPS antenna connector
- 3: Grounding bolt
- 4: J1 (serial interfaces)
- 5: P1 (digital & analog I/Os)

Figure 18: BD406 – Connector Layout (rear side)

2.5.1.1 406 MHz Antenna Connector (ANT)

Position 1:

Type: BNC type

Nominal impedance: 50 Ω

Recommended cable type: RG223/U (RG58C/U acceptable).

2.5.1.2 GPS Antenna Connector (GPS)

Position 2:

Type: TNC type

Recommended cable type: RG223/U (RG58C/U acceptable).

The antenna input delivers bias voltage in a range of 2.75...3.40 VDC, maximal load current 50 mA to supply active antennas.

The device operates with active antennas:

- Antenna minimum gain: 15 dB
- Antenna maximum gain: 50 dB
- Antenna maximum noise: 1.5 dB

2.5.1.3 Grounding Bolt

Position 3:

Type: M4 thread screw, washers and nuts included.

Use this bolt for low impedance grounding of the device.

Note: Low impedance grounding is essential to prevent damage or malfunction in case of indirect lightning, EMI and HIRF conditions.

2.5.1.4 Device Connector P1 - Digital and Analog I/Os

Position 4:

Type: DB-25 D-SUB, 25-pol. male connector, slide-in fastener.

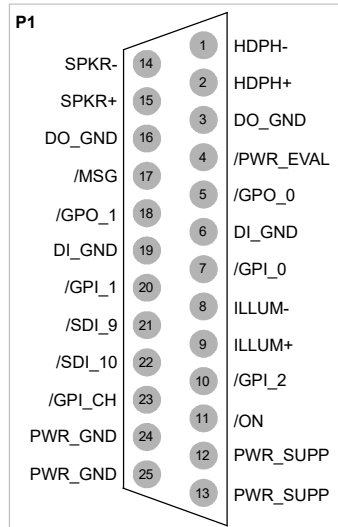

Figure 19: Connector Layout P1 - Digital and Analog I/O (rear side)

NOTICE

BD406 without control head:

The BD406 without control head can be only powered-on when P1-11 pin (/ON input) is connected to P1-19 DI_GND.

P1 Pin	Type	I/O	Name	Function	Recommended cable type
1	Analog	O	HDPH-	Headphone output return signal (headphone output is balanced). Not used for BD406 without control head.	AWG 20 - 22 best performance with AWG20 shielded, as short as possible
2	Analog	O	HDPH+	Headphone output signal (headphone output is balanced). Not used for BD406 without control head.	
3	Ground	--	DO_GND	Discrete output ground (signal return for pins 4, 5, 17, 18). Not used for BD406 without control head.	AWG22
4	Discrete	O	/PWR_EVAL	Device enabled status. Active state = device enabled. Not used for BD406 without control head.	AWG22
5	Discrete	O	/GPO_0	Configurable general purpose output. Not used for BD406 without control head.	AWG22
6	Ground	--	DI_GND	Discrete input ground (signal return for pins 7, 10, 11, 20, 21, 22, 23). Not used for BD406 without control.	AWG22
7	Discrete	I	/GPI_0	Configurable general purpose input. Not used for BD406 without control.	AWG22
8	Analog	I	ILLUM-	Adjustment display backlight. Not used for BD406 without control.	AWG22
9	Analog	I	ILLUM+	Adjustment display backlight. Not used for BD406 without control.	AWG22

P1 Pin	Type	I/O	Name	Function	Recommended cable type
10	Discrete	I	/GPI_2	General purpose input. Reserved for future use. Not used for BD406 without control.	AWG22
11	Discrete	I	/ON	Device remote enabling. Active state = device enabled.	AWG22
12	Analog	I	PWR_SUPP	Positive power supply line. External 2.5 A fuse for current protection.	AWG20
13	Analog	I	PWR_SUPP	Positive power supply line. External 2.5 A fuse for current protection.	AWG20
14	Analog	O	SPKR-	Speaker output return signal (on GND potential. Speaker output is unbalanced.). Not used for BD406 without control.	AWG 20-22 best performance with AWG20 shielded, as short as possible
15	Analog	O	SPKR+	Speaker output signal. Not used for BD406 without control.	
16	Ground	--	DO_GND	Discrete output ground (signal return for pins 4, 5, 17, 18). Not used for BD406 without control.	AWG22
17	Discrete	O	/MSG	Signalization of the reception of valid message. Not used for BD406 without control.	AWG22
18	Discrete	O	/GPO_1	Configurable general purpose output. Not used for BD406 without control.	AWG22
19	Ground	--	DI_GND	Discrete input ground (signal return for pins 7, 10, 11, 20, 21, 22, 23).	AWG22
20	Discrete	I	/GPI_1	General purpose input. Reserved for future use. Not used for BD406 without control.	AWG22
21	Discrete	I	/SDI_9	SDI field of ARINC 429 frame configuration (bit 9). Active state of the pin results in bit 9 of ARINC frames set to 1. Not used for BD406 without control.	AWG22
22	Discrete	I	/SDI_10	SDI field of ARINC 429 frame configuration (bit 10). Active state of the pin results in bit 10 of ARINC frames set to 1. Not used for BD406 without control.	AWG22
23	Discrete	I	/GPI_CH	Spare discrete input pin of CH for future use. Not used for BD406 without control.	AWG22
24	Ground	--	PWR_GND	Negative power supply line, PWR_SUPP signal return	AWG20
25	Ground	--	PWR_GND	Negative power supply line, PWR_SUPP signal return	AWG20

2.5.1.5 Device Connector J1 - Serial Interfaces

Position 4:

Type: DB-25 D-SUB, 25-pol. female connector, slide-in fastener.

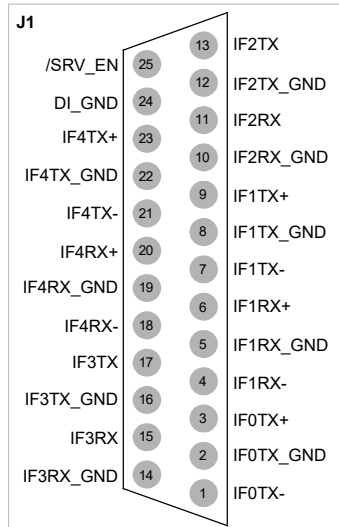

Figure 20: Connector Layout J1 - Serial Interfaces (rear side)

J1 Pin	Type	I/O	Name	Function	Recommended cable type	Remarks
1	Discrete	O	IF0TX-	IF0 interface negative bus of the transmitter. Not used for BD406 without control.	AWG26	IF0 is ARINC 429 compliant output interface.
2	Ground	--	IF0TX_GND	IF0 interface ground of the transmitter. Not used for BD406 without control.	AWG26	
3	Discrete	O	IF0TX+	IF0 interface positive bus of the transmitter. Not used for BD406 without control.	AWG26	

J1 Pin	Type	I/O	Name	Function	Recommended cable type	Remarks	
4	Discrete	I	IF1RX-	IF1 interface negative bus of the receiver. Not used for BD406 without control.	AWG26	IF1 is RS422 compliant interface for service purposes.	
5	Ground	--	IF1RX_GND	IF1 interface ground of the receiver. Not used for BD406 without control.	AWG26		
6	Discrete	I	IF1RX+	IF1 interface positive bus of the receiver. Not used for BD406 without control.	AWG26		
7	Discrete	O	IF1TX-	IF1 interface negative bus of the transmitter. Not used for BD406 without control.	AWG26		
8	Ground	--	IF1TX_GND	IF1 interface ground of the transmitter. Not used for BD406 without control.	AWG26		
9	Discrete	O	IF1TX+	IF1 interface positive bus of the transmitter. Not used for BD406 without control.	AWG26		
10	Ground	--	IF2RX_GND	IF2 interface ground of the receiver. Not used for BD406 without control.	AWG26		IF2 is RS232 compliant interface for internal/external GPS data transmission.
11	Discrete	I	IF2RX	IF2 interface bus of the receiver. Not used for BD406 without control.	AWG26		
12	Ground	--	IF2TX_GND	IF2 interface ground of the transmitter. Not used for BD406 without control.	AWG26		
13	Discrete	O	IF2TX	IF2 interface bus of the transmitter. Not used for BD406 without control.	AWG26		
14	Ground	--	IF3RX_GND	IF3 interface ground of the receiver. Not used for BD406 without control.	AWG26	IF3 receiver is RS232 compliant interface for future use.	
15	Discrete	I	IF3RX	IF3 interface bus of the receiver. Not used for BD406 without control.	AWG26		
16	Ground	--	IF3TX_GND	IF3 interface ground of the transmitter.	AWG26	IF3 transmitter is RS232 compliant interface for continuous transmission of the status of the targets.	
17	Discrete	O	IF3TX	IF3 interface bus of the transmitter.	AWG26		

Electrical Interface

J1 Pin	Type	I/O	Name	Function	Recommended cable type	Remarks
18	Discrete	I	IF4RX-	IF4 interface negative bus of the receiver. Not used for BD406 without control.	AWG26	IF4 is RS422 compliant auxiliary interface for future use (it allows direct communication with the control head)
19	Ground	--	IF4RX_GND	IF4 interface ground of the receiver. Not used for BD406 without control.	AWG26	
20	Discrete	I	IF4RX+	IF4 interface positive bus of the receiver. Not used for BD406 without control.	AWG26	
21	Discrete	O	IF4TX-	IF4 interface negative bus of the transmitter. Not used for BD406 without control.	AWG26	
22	Ground	--	IF4TX_GND	IF4 interface ground of the transmitter. Not used for BD406 without control.	AWG26	
23	Discrete	O	IF4TX+	IF4 interface positive bus of the transmitter. Not used for BD406 without control.	AWG26	
24	Ground	--	DI_GND	Discrete input ground (signal return pin 25). Not used for BD406 without control.	AWG22	
25	Discrete	I	/SRV_EN	Service Mode Activation. Not used for BD406 without control.	AWG22	

2.5.2 Connector Pin Assignments - PBD406

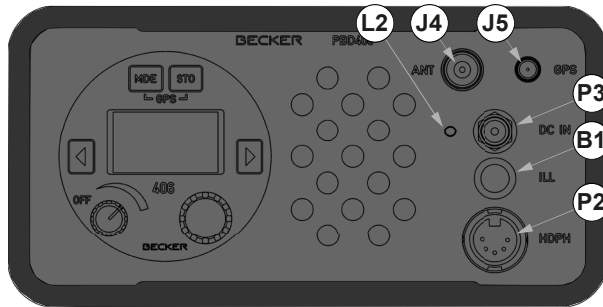

Figure 21: PBD406 – Connector Layout (front side)

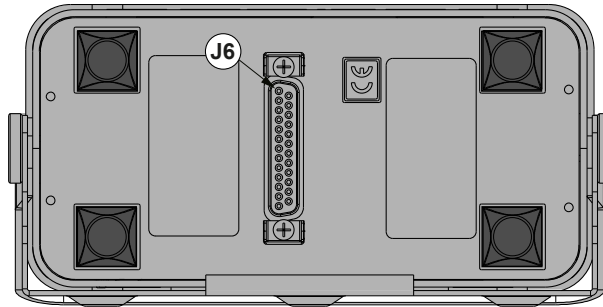

Figure 22: PBD406 – Connector Layout (rear side)

- J4: 406 MHz antenna connector
- J5: GPS antenna connector
- P3: External DC voltage
- P2: Headphone / speaker output
- B1: Illumination button
- L2: LED, external voltage indicator
- : Speaker

- J6: Serial interface

2.5.2.1 406 MHz Antenna Connector (ANT)

Position J4:

Type: BNC type

2.5.2.2 GPS Antenna Connector (GPS)

Position J5:

Type: GPS SMA Jack

2.5.2.3 External DC Voltage (DC IN)

Position P3:

Type: DIN Jack

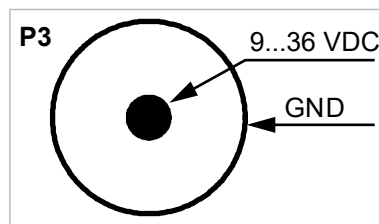

Figure 23: PBD406 – Connector P3 (front side)

- Connector P3 for external power supply.

2.5.2.4 Headphone / Speaker Output (HDPH)

Position P2:

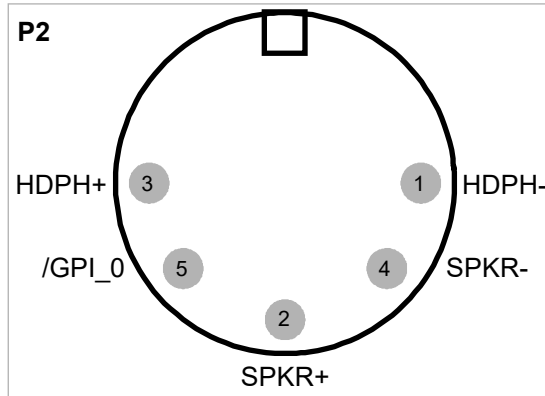

Figure 24: PBD406 – Connector P2 (front side)

- Connector P2 is internally connected to the related pins of P1 connector (BD406) see "Device Connector P1 - Digital and Analog I/Os" page 46.
- If /GPI_0 pin on P2 connector is used, the pin is in active state if connected to the SPKR- pin.
- HDPH+/HDPH- pins are for high impedance headsets.
- SPKR+/SPKR- pins are for low impedance headsets.

2.5.2.5 Device Connector J6

Position J6:

Type: DB-25 D-SUB, 25 pol. female connector, slide-in fastener.

The pin assignment of the device connector J6 on the rear side is equal to J1 connector of BD406 (see "Device Connector J1 - Serial Interfaces" page 48).

2.5.3 Inputs / Outputs

The wiring of BD406 with and without control head is different, for details see connector tables:

- "Device Connector P1 - Digital and Analog I/Os" page 46.
- "Device Connector J1 - Serial Interfaces" page 48.

2.5.3.1 Speaker Connection

Pin	Type	I/O	Name	Function	Remarks
14	Analog	O	SPKR-	Speaker output return signal. On GND potential. Speaker output is unbalanced.	P1 connector
15	Analog	O	SPKR+	Speaker output signal	P1 connector

The speaker output has a nominal 4 W into 4 Ω load. For best performance use a pair of shielded wires and wiring path as short as possible.

It is recommended to install the speaker and wiring shields isolated from aircraft frame to prevent ground loops. Pin 14 SPKR- is internally connected to the GND potential.

Caution: The magnetic field of a speaker can influence the magnetic compass.

Obey the requirements "Installation Requirements" page 37. After speaker installation examine accuracy of the compass operation.

2.5.3.2 Headphone Connection

Pin	Type	I/O	Name	Function	Remarks
1	Analog	O	HDPH-	Headphone output return signal (balanced)	P1 connector
2	Analog	O	HDPH+	Headphone output signal (balanced)	P1 connector

The headphone output is a balanced, transformer-coupled output has nominal 300 mW into 150 Ω. It is highly recommended to install the jacks isolated from aircraft frame to prevent ground loops.

2.5.3.3 Panel Illumination

Pin	Type	I/O	Name	Function	Remarks
8	Analog	I	ILLUM-	Adjustment of display backlight.	P1 connector
9	Analog	I	ILLUM+	Adjustment of display backlight.	P1 connector

The BD406 has illuminated push buttons and an LCD. The illumination can be configured for front panel or external control (P1, pins 8, 9).

Connect ILLUM- (pin 8) to system ground.

Connect ILLUM+ (pin 9) to a dimming voltage bus.

2.5.3.4 /PWR_EVAL

Pin	Type	I/O	Name	Function	Remarks
4	Discrete	O	/PWR_EVAL	Device power on/off indicator.	P1 connector

This output shows if the transceiver is on or off.

It is an open collector output type. Maximal load current is 20 mA.

When the device is operational, the pin is active – it has low impedance to GND.

When the device is off, the output has high impedance to GND.

If not used, keep pin(s) unconnected.

2.5.3.5 /MSG

Pin	Type	I/O	Name	Function	Remarks
17	Discrete	O	/MSG	Signal of reception of valid message.	P1 connector

This output shows if a valid COSPAS/SARSAT signal is received by the receiver.

It is an open collector output type. Maximal load current is 20 mA.

When beacon message is received – the output has low impedance to GND (is active) for 400 ms.

In inactive state the output has high impedance to GND.

The output has high impedance when the device is off.

If not used, keep pin(s) unconnected.

2.5.3.6 /GPO_0

Pin	Type	I/O	Name	Function	Remarks
5	Discrete	O	/GPO_0	Configurable general purpose output.	P1 connector

This output indicates if a valid COSPAS/SARSAT signal that is not recorded in the beacon database is received by the receiver.

It is an open collector output type. Maximal load current is 20 mA.

When beacon message is received – the output has low impedance to GND (is active) for 400 ms.

In inactive state the output has high impedance to GND.

The output has high impedance when the device is off.

If not used, keep pin(s) unconnected.

Electrical Interface

2.5.3.7 /GPO_1

Pin	Type	I/O	Name	Function	Remarks
18	Discrete	O	/GPO_1	Configurable general purpose output.	P1 connector

The output has high impedance to GND when the device is off.

If not used, keep pin(s) unconnected.

2.5.3.8 /GPI_0

Pin	Type	I/O	Name	Function	Remarks
7	Discrete	I	/GPI_0	Configurable general purpose input.	P1 connector

When it is activated and connected to DI_GND, voice notification of homing is audible (details "Audio Notification" page 85).

2.5.3.9 /GPI_1, /GPI_2

Pin	Type	I/O	Name	Function	Remarks
20	Discrete	I	/GPI_1	General purpose input. Reserved for future use.	P1 connector
10	Discrete	I	/GPI_2	General purpose input. Reserved for future use.	P1 connector

If not used, keep pin(s) unconnected.

2.5.3.10 /ON

Pin	Type	I/O	Name	Function	Remarks
11	Discrete	I	/ON	Device remote enabling. Active state (GND) of the pin sets the device on.	P1 connector

When this input is connected to DI_GND the device is set to on.

2.5.3.11 /SDI_9, SDI_10

Pin	Type	I/O	Name	Function	Remarks
21	Discrete	I	/SDI_9	For SDI field of ARINC 429 frame configuration (bit 9). Pin to GND results in bit 9 of ARINC frames is set to 1.	P1 connector
22	Discrete	I	/SDI_10	For SDI field of ARINC 429 frame configuration (bit 10). Pin to GND results in bit 10 of ARINC frames is set to 1.	P1 connector

Inputs for SDI bits 9/10 status in ARINC 429 frames.

Connect pins to GND or if not used, keep pin unconnected.

2.5.3.12 /GPI_CH

Pin	Type	I/O	Name	Function	Remarks
23	Discrete	I	/GPI_CH	Spare discrete input of CH. Reserved for future use.	P1 connector

If not used, keep pin(s) unconnected.

2.5.3.13 IF0 - ARINC Output

Pin	Type	I/O	Name	Function	Remarks
1	Discrete	O	IF0TX-	IF0 interface negative bus of the transmitter.	J1 connector
2	Ground	--	IF0TX_GND	IF0 interface ground of the transmitter.	J1 connector
3	Discrete	O	IF0TX+	IF0 interface positive bus of the transmitter.	J1 connector

IF0 is an ARINC 429 compliant output interface.

It supports transmission speeds: 12.5 kbps, 100 kbps.

Refer to ARINC 429 specification for details on wiring and electrical requirements.

If not used, keep pin(s) unconnected.

2.5.3.14 IF1 - Service Protocol Interface

Pin	Type	I/O	Name	Function	Remarks
4	Discrete	I	IF1RX-	IF1 interface negative bus of the receiver.	J1 connector
5	Ground	--	IF1RX_GND	IF1 interface ground of the receiver.	J1 connector
6	Discrete	I	IF1RX+	IF1 interface positive bus of the receiver.	J1 connector
7	Discrete	O	IF1TX-	IF1 interface negative bus of the transmitter.	J1 connector
8	Ground	--	IF1TX_GND	IF1 interface ground of the transmitter.	J1 connector
9	Discrete	O	IF1TX+	IF1 interface positive bus of the transmitter.	J1 connector
24	Ground	--	DI_GND	Discrete inputs ground (signal return for pin 25).	J1 connector
25	Discrete	I	/SRV_EN	Dedicated for Service Mode Activation.	J1 connector

IF1 is a RS422 compliant interface for service functions.

It is a proprietary serial data communication protocol for control, calibration and configuration of the device.

2.5.3.15 IF2 - GPS Interface (external/internal)

Pin	Type	I/O	Name	Function	Remarks
10	Ground	--	IF2RX_GND	IF2 interface ground of the receiver	J1 connector
11	Discrete	I	IF2RX	IF2 interface bus of the receiver	J1 connector
12	Ground	--	IF2TX_GND	IF2 interface ground of the transmitter	J1 connector
13	Discrete	O	IF2TX	IF2 interface bus of the transmitter	J1 connector

IF2 is a RS232 compliant interface for an internal/external GPS data transmission.

When internal GPS receiver is active - routed frames from internal GPS are present on IF2TX (an external listener can listen to the frames from internal GPS source).

When an external GPS is active, connect the IF2RX to a valid GPS data source compliant with NMEA-0183. The source must send GGA, VTG, RMC, GSA frames.

To listen to the routed transmission of internal GPS source set these transmission parameters:

Baud rate: 9600 bps

Data bits: 8 bits

Electrical Interface

Stop bits: 1 bit

Parity: NONE

External GPS source must send data source with these range of transmission parameters (configurable in installation setup):

Baud rate: 1200, 2400, 4800, 9600, 19200 bps

Data bits: 7, 8 bits

Stop bits: 1, 2 bit

Parity: NONE, EVEN, ODD

2.5.3.16 IF3 – Transmitter of Targets Status Protocol

Pin	Type	I/O	Name	Function	Remarks
16	Ground	--	IF3TX_GND	IF3 interface ground of the transmitter	J1 connector
17	Discrete	O	IF3TX	IF3 interface bus of the transmitter	J1 connector

IF3 transmitter is a RS232 compliant interface for targets status data transmission.

If targets status transmission is enabled pin IF3TX can supply data about all beacons and NavPoints registered in internal memory during mission.

Details "Targets Status Protocol - IF3 Interface" page 73.

If not used, keep pin(s) unconnected.

2.5.3.17 IF3 - Receiver

Pin	Type	I/O	Name	Function	Remarks
14	Ground	--	IF3RX_GND	IF3 interface ground of the receiver	J1 connector
15	Discrete	I	IF3RX	IF3 interface bus of the receiver	J1 connector

IF3 receiver is a RS232 compliant interface.

If not used, keep pin(s) unconnected.

2.5.3.18 IF4 - General Purpose Interface

Pin	Type	I/O	Name	Function	Remarks
18	Discrete	I	IF4RX-	IF4 interface negative bus of the receiver	J1 connector
19	Ground	--	IF4RX_GND	IF4 interface ground of the receiver	J1 connector
20	Discrete	I	IF4RX+	IF4 interface positive bus of the receiver	J1 connector
21	Discrete	O	IF4TX-	IF4 interface negative bus of the transmitter	J1 connector

IF4 is a RS422 compliant interface.

If not used, keep pin(s) unconnected.

2.6 Aircraft Wiring

**SAFETY
INSTRUCTIONS**

The installation of the device(s) depends on the device, the type of aircraft and its equipment and therefore only general information can be given in this section.

Required as minimum wiring:

- Supply voltage.
- Antenna RF.
- GPS antenna or external GPS source (for full performance of the device).

Notice: Obey "Installation Requirements" page 37 and recommended cable types see "Electrical Interface" page 45.

2.6.1 Electrical Bonding and Grounding

**SAFETY
INSTRUCTIONS**

- Make sure that the device is correctly connected to aircraft ground (structure).
- Make sure that the electrical bonding area is protected to prevent corrosion

See also "Grounding Bolt" page 45.

2.6.2 Wiring - BD406 with Control Head, P1 Connector and Antennas

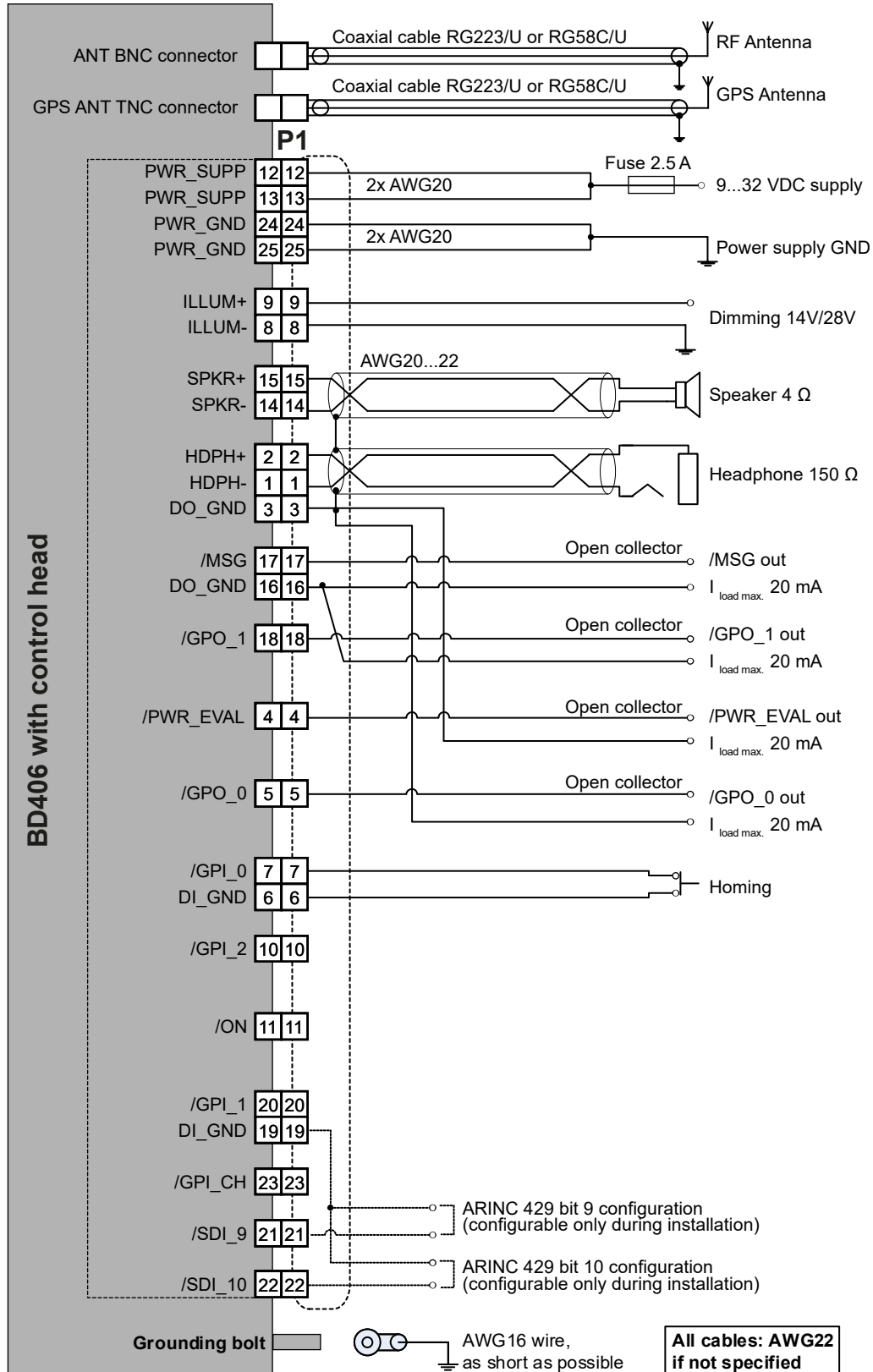

Figure 25: Wiring - BD406 with Control Head, P1 Connector and Antennas

2.6.3 Wiring - BD406 with Control Head, J1 Connector (PBD406 J6 Connector)

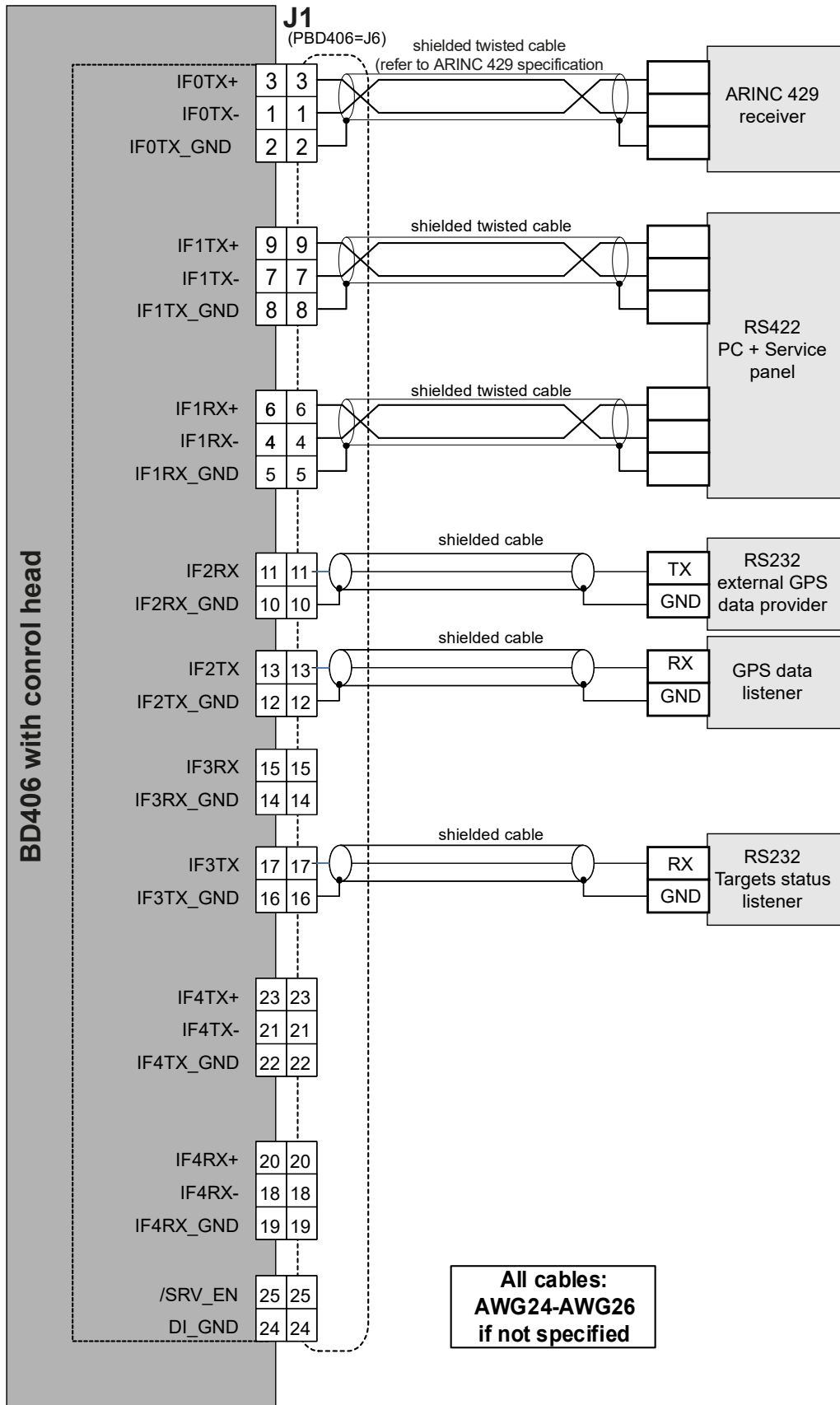

Figure 26: Wiring - BD406 with Control Head, J1 Connector (PBD406 J6 Connector)

2.6.4 Wiring - BD406 without Control Head, P1 Connector and Antennas

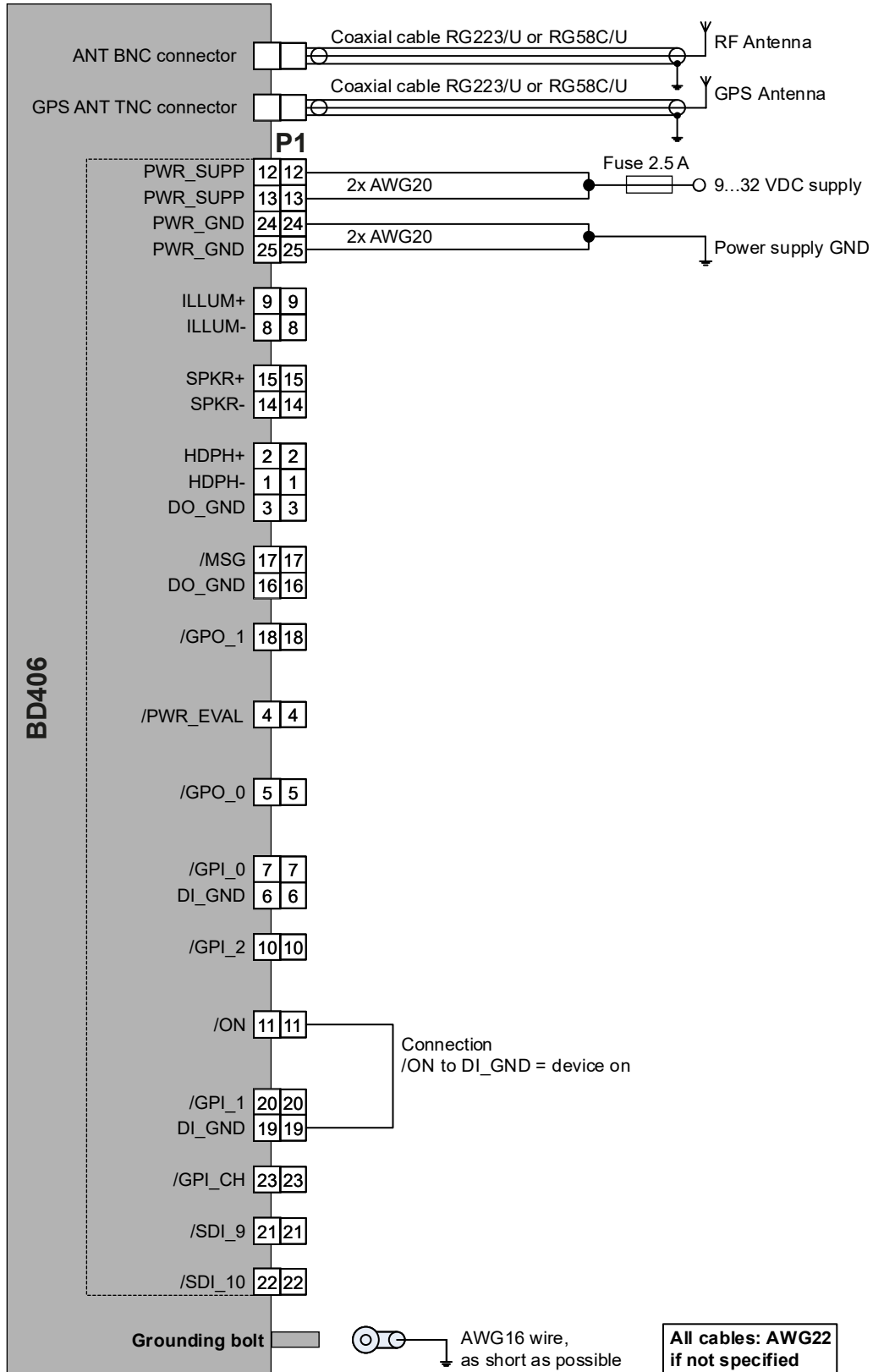

Figure 27: Wiring - BD406 without Control Head, P1 Connector and Antennas

2.6.5 Wiring - BD406 without Control Head, J1 Connector

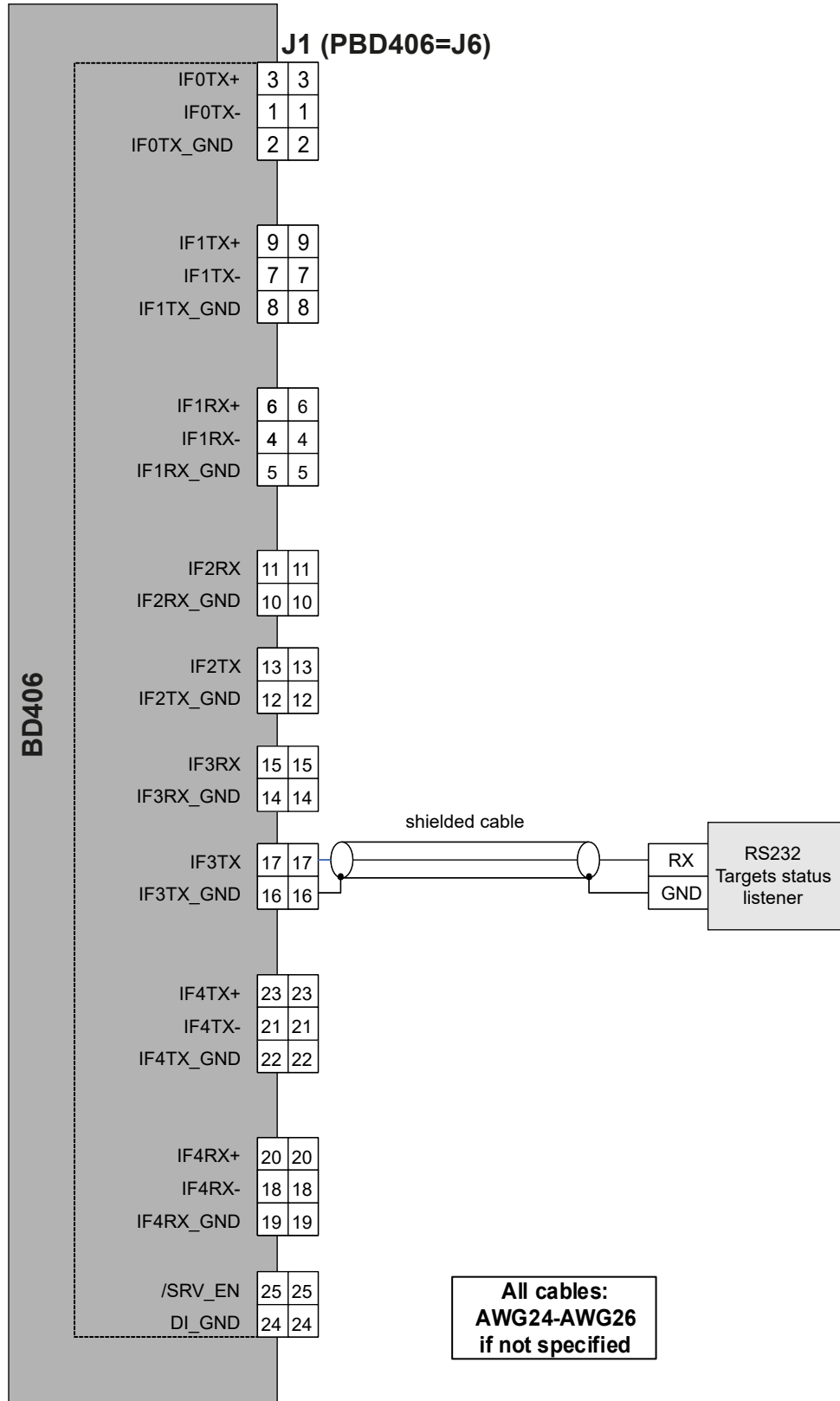

Figure 28: Wiring - BD406 without Control Head, J1 Connector

2.6.6 Antenna Installation

- The BD406/PBD406 require a standard 50 Ω vertically polarized UHF antenna for dedicated band.
- An active GPS antenna is necessary to use the full functionality of the device.
- Obey the installation instructions from antenna manufacturer.

⚠ CAUTION

- Connect active GPS antenna to the BD406/PBD406 when it is **not** powered-on.
- Do not connect or disconnect the GPS antenna when the device operates, as the internal GPS receiver calibrates the noise floor on power-up.
- To connect the antenna after power-up can cause an extended acquisition time.

2.7 Installation Setup

The installation setup is for the configuration of installation and device parameters.

NOTICE



We do not recommend to do changes on the configuration setup in-flight.

BD406 without control head:

Only manufacturer (on customer request) configures specific installation settings. Contact manufacturer to change current configuration when device is already delivered.

2.7.1 Start Installation Setup

User interface see "Controls and Indications" page 82.

	<ul style="list-style-type: none"> • Push and hold the "MDE" key during power up. <ul style="list-style-type: none"> ○ The configuration setup starts. • Push any key to continue.
 <p>Figure 29: "PASSWORD"</p>	<ul style="list-style-type: none"> • The display shows the screen "PASSWORD". • Insert the 4-digit numerical code password "6435" by turn and push the rotary knob. • Push the "STO" key to complete the entry.



Short push left key (<):

- Selects the digit before (loop function).



Short push right key (>):

- Selects the next digit (loop function).

Short push STO:

- If password is set to 6435 device enables installation setup, other passwords are ignored.

Left/ right turn rotary knob:

- Decreases/increases selected digit by one (loop function, 0-9).

Short push rotary knob:

- Selects next digit (loop function).

2.7.1.1 **Navigate between Pages**

Page Down (next page):	<ul style="list-style-type: none"> • Push right change key (>)
Page Up (page before):	<ul style="list-style-type: none"> • Push left change key (<)

2.7.1.2 **Store Setup Data**

- The change of any parameter is stored immediately.

2.7.1.3 **Cancel the Installation Setup**

- Turn "OFF" the device to stop the setup.
 - All changes made up to this time are stored automatically.

2.7.2 **Device Info**

The first page of configuration setup shows the device info screens.

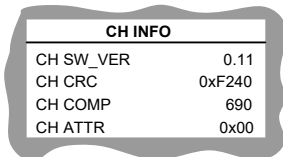
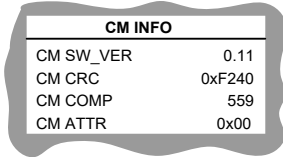
Display Contents	Description
 <p>Figure 30: "CH INFO"</p>	<p>"CH INFO":</p> <ul style="list-style-type: none"> • The display shows the control head (CH) software version. It is a read only information.
 <p>Figure 31: "CM INFO"</p>	<p>"CM INFO":</p> <ul style="list-style-type: none"> • The display shows the chassis module (CM) software version. It is a read only information.

2.7.3 General Configuration

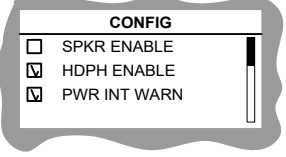
Display Contents	Description
 <p> <input type="checkbox"/> ARINC ENABLE <input type="checkbox"/> HDPHONE ENABLE <input type="checkbox"/> /MSG OUT ENABLE <input type="checkbox"/> PWR INT WARNING <input type="checkbox"/> SPKR ENABLE <input type="checkbox"/> TARGET STATUS ENA </p>	<p>"CONFIG":</p> <ul style="list-style-type: none"> • Select function(s) required for the installation. • Use the rotary knob for selection. • Push the "STO" key to confirm. <p>ARINC ENABLE:</p> <ul style="list-style-type: none"> • If enabled - interface IF0 is active. Details "IF0 - ARINC Output" page 55. <p>HDPHONE ENABLE:</p> <ul style="list-style-type: none"> • If selected - audio notifications are audible at headphones. Details "Headphone Connection" page 53. <p>/MSG OUT ENABLE:</p> <ul style="list-style-type: none"> • If selected - /MSG output is active when COSPAS/SARSAT is received by the device. Details "/MSG" page 53. <p>PWR INT WARNING:</p> <ul style="list-style-type: none"> • If selected - warning power interrupt notification is shown on screen when power malfunction occurs. Details "Power Interrupt Indication" page 88. <p>SPEAKER ENABLE:</p> <ul style="list-style-type: none"> • If selected - audio notifications are audible at speaker output. Details "Speaker Connection" page 52. <p>TARGETS STATUS ENABLE:</p> <ul style="list-style-type: none"> • If selected – interface IF3 (transmitter) is active. Details "IF3 – Transmitter of Targets Status Protocol" page 56. <p>Notice: It is recommended to deactivate related checkbox option, if dedicated output is not used in aircraft installation.</p>

2.7.4 Audio Warnings

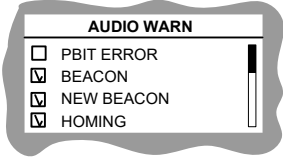
Display Contents	Description
	<p>"AUDIO WARN":</p> <ul style="list-style-type: none"> • When selected voice notifications are audible on headphones/speaker. • Select function(s) required for the installation. • Use the rotary knob for selection. • Push the "STO" key to confirm. <p>PBIT Error:</p> <ul style="list-style-type: none"> • When PBIT error appears voice notification is audible: Beacon Decoder Failure. <p>Beacon:</p> <ul style="list-style-type: none"> • When COSPAS/SARSAT message is received voice notification is audible: Beacon. <p>New Beacon:</p> <ul style="list-style-type: none"> • When not registered in internal database COSPAS/SARSAT message is received voice notification appears: New Beacon. <p>Homing:</p> <ul style="list-style-type: none"> • When rotary knob is pushed or /GPI_0 is activated voice notification appears: True Bearing XXX degrees, Distance YYY.Y kilometers/miles where XXX/YYY.Y are digits.

2.7.5 Dimming Input

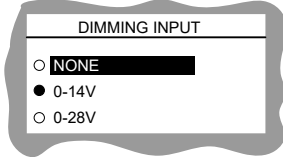
Display Contents	Description
	<p>" DIMMING INPUT":</p> <ul style="list-style-type: none"> • Select function(s) required for the installation. • One of the three must be selected. • Use the rotary knob for selection. • Push the "STO" key to confirm. <p>NONE:</p> <ul style="list-style-type: none"> • The illumination for LCD and keys will be controlled through the rotary knob (only in installation mode, see next screen). This function shall be selected in aircrafts where a dimming bus is not available. <p>0-14V:</p> <ul style="list-style-type: none"> • The illumination for LCD and keys will be controlled (pin P1-9/P1-8) by the dimming bus of the aircraft. • The dimming voltage is in range 0...14 VDC. <p>0-28V:</p> <ul style="list-style-type: none"> • The illumination for LCD and keys will be controlled (pin P1-9/P1-8) by the dimming bus of the aircraft. • The dimming voltage is in range 0...28 VDC <p>Notice: For PBD406 set DIMMING INPUT to 0-14V.</p>

2.7.6 Brightness

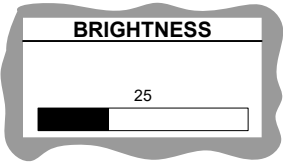
Display Contents	Description
 <p>The screenshot shows a display titled "BRIGHTNESS" with a horizontal progress bar. The bar is partially filled with black, and the number "25" is displayed above it. Below the bar, the text "0% (off)... 100%" is visible.</p>	<p>"BRIGHTNESS": Notice: This page is shown only when the dimming input is set to "NONE". Otherwise the aircraft dimming bus controls the brightness.</p> <ul style="list-style-type: none"> • Backlight brightness adjustment. • Select function(s) required for the installation. • Use the rotary knob to set the brightness. • Brightness can be set in range 0...100. • 0: value bar is not filled. • 100: value bar is fully filled.

2.7.7 Illumination Curve

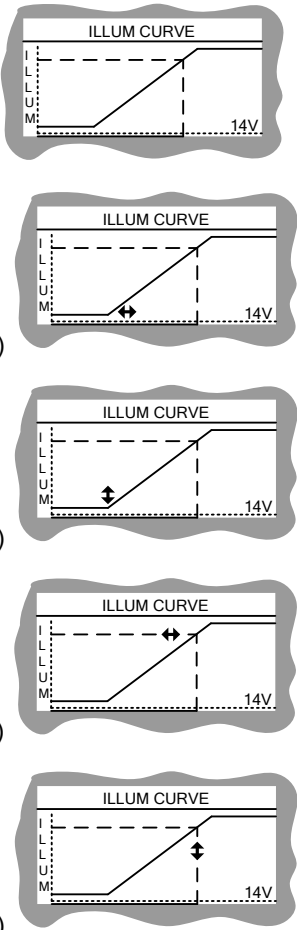
Display Contents	Description
 <p>The diagrams show the "ILLUM CURVE" display with a graph of brightness vs. voltage. The graph has a horizontal segment at 0 brightness up to voltage V1, a linear increase from V1 to V2, and a horizontal segment at maximum brightness above V2. The y-axis is labeled with L, U, M and the x-axis with 14V.</p> <p>a) Voltage V1 to start the brightness increase (below V1 brightness is 0).</p> <p>b) Minimum brightness if V1 is just reached.</p> <p>c) Voltage V2 for which maximum brightness is reached (above V2 brightness is constant).</p> <p>d) Maximum brightness.</p>	<p>"ILLUM CURVE": Notice: This page is shown only when the the DIMMING input is selected for "14 V or 28 V" dimming inputs voltage and for LCD with white backlight (standard). For LCD with NVG compatible backlight this screen is not available.</p> <ul style="list-style-type: none"> • The illumination curve shows the relation between dimming bus voltage and brightness of the LCD and key illumination. • Two adjustable points V1 and V2 define the illumination curve. • Select function(s) required for the installation. • Use STO key select sub-screens (loop function). • Adjust the value in horizontal (left/right), vertical (up/down) direction with the rotary knob.

2.7.8 Load Default

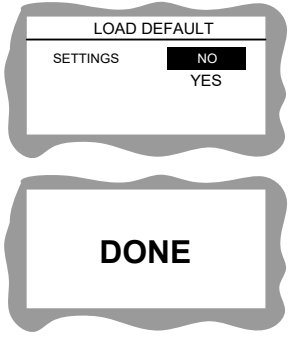
Display Contents	Description
	<p>"LOAD DEFAULT":</p> <ul style="list-style-type: none"> Recall default settings. <p>To restore the factory default settings:</p> <ul style="list-style-type: none"> Select "YES" with the rotary knob. Push the "STO" key to confirm. <ul style="list-style-type: none"> The screen shows "DONE" for 1 s. The receiver ignores any other user operation. <p>Notice: Stored data will be overwritten.</p>

Default Settings

Adjustment name	Value
/MSG Output Enable:	Active
ARINC Baud Rate:	12.5 kbit/s
ARINC Enable:	Inactive
Targets Status:	
Baud Rate:	9600
Data Bits:	8
Parity:	NONE
Stop Bits:	1
EXT GPS CONFIG:	
Baud Rate:	4800
Data Bits:	7
Parity:	NONE
Stop Bits:	1
/GPO_0 Function:	NONE
/GPI_0 Function:	NONE
GPS Source:	INTERNAL
HDPH Enable:	Active
PWR_INT	
Warnings Enable:	Active
SPKR Enable:	Active
Targets Status Enable:	Active
Second Controller on IF1:	Inactive
Audio Messages:	
Beacon Enable:	Inactive
Homing Enable:	Inactive
New Beacon Enable:	Inactive
PBIT Error Enable:	Inactive

2.7.9 GPS Source Selection

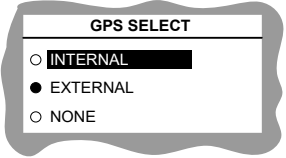
Display Contents	Description
	<p>"GPS SELECT":</p> <ul style="list-style-type: none"> • Select function(s) required for the installation. • One of the three must be selected. • Use the rotary knob for selection. • Push the "STO" key to confirm. <p>INTERNAL:</p> <ul style="list-style-type: none"> • Internal GPS receiver is enabled. <p>EXTERNAL:</p> <ul style="list-style-type: none"> • GPS receiver connected to IF2 interface is enabled. Details "IF2 - GPS Interface (external/internal)" page 55. <p>NONE:</p> <ul style="list-style-type: none"> • GPS receiver is disabled.

2.7.10 External GPS Receiver Configuration

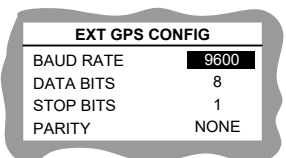
Display Contents	Description
	<p>"EXT GPS CONFIG":</p> <p>Notice: The screen is visible only if GPS source is set to EXTERNAL.</p> <ul style="list-style-type: none"> • Select function(s) required for the installation. • Use the rotary knob to select parameter. • Use the "STO" key to change values. <p>Available values:</p> <p>Baud Rate: 1200, 2400, 4800, 9600, 19 200</p> <p>Data Bits: 7, 8</p> <p>Stop Bits: 1, 2</p> <p>GPS Parity: NONE, EVEN, ODD</p>

2.7.11 Target Status Protocol

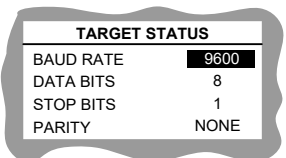
Display Contents	Description
	<p>"TARGET STATUS":</p> <p>Notice: This screen is visible only if targets status is ENABLED. Details "Targets Status Protocol - IF3 Interface" page 73.</p> <ul style="list-style-type: none"> • Use for targets status protocol transmission. • Select function(s) required for the installation. • Use the rotary knob to select parameter. • Use the "STO" key to change values. <p>Available values:</p> <p>Baud Rate: 1200, 2400, 4800, 9600, 19 200</p> <p>Data Bits: 8</p> <p>Stop Bits: 1, 2</p> <p>GPS Parity: NONE, EVEN, ODD</p>

2.7.12 ARINC 429

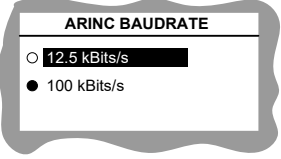
Display Contents	Description
 <p>The screenshot shows a menu titled "ARINC BAUDRATE" with two radio button options: "12.5 kBits/s" (unselected) and "100 kBits/s" (selected).</p>	<p>"ARINC BAUDRATE":</p> <ul style="list-style-type: none"> • Used for ARINC 429 baud rate selection. • Select function(s) required for the installation. • Use the rotary knob to select parameter. • Push the "STO" key to confirm.

2.7.13 GPO_0

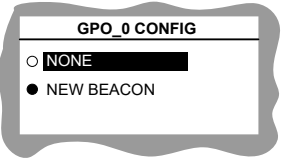
Display Contents	Description
 <p>The screenshot shows a menu titled "GPO_0 CONFIG" with two radio button options: "NONE" (unselected) and "NEW BEACON" (selected).</p>	<p>"GPO_0 CONFIG":</p> <ul style="list-style-type: none"> • Select function(s) required for the installation. • Use the rotary knob for selection. • Push the "STO" key to confirm. <p>NONE:</p> <ul style="list-style-type: none"> • The output is disabled. <p>NEW BEACON:</p> <ul style="list-style-type: none"> • The output is active when a new (not registered in memory) message is received.

2.7.14 GPI_0

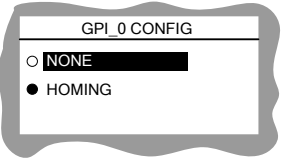
Display Contents	Description
 <p>The screenshot shows a menu titled "GPI_0 CONFIG" with two radio button options: "NONE" (unselected) and "HOMING" (selected).</p>	<p>"GPI_0 CONFIG":</p> <ul style="list-style-type: none"> • Select function(s) required for the installation. • Use the rotary knob for selection. • Push the "STO" key to confirm. <p>NONE:</p> <ul style="list-style-type: none"> • The input is disabled. <p>HOMING:</p> <ul style="list-style-type: none"> • Voice notification about homing (true bearing, distance) is audible when rotary knob is pushed in mission mode.

2.7.15 Control Head Interface

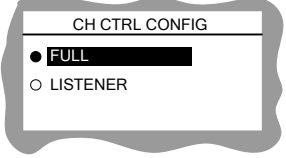
Display Contents	Description
 <p>The screenshot shows a menu titled "CH CTRL CONFIG". There are two options: "FULL" with a filled radio button and "LISTENER" with an empty radio button.</p>	<p>"CH CTRL CONFIG":</p> <ul style="list-style-type: none"> • Select function(s) required for the installation. • Use the rotary knob for selection. • Push the "STO" key to confirm. <p>FULL:</p> <ul style="list-style-type: none"> • Default setting: Control head is in nominal transmission mode transmits and receives data/configuration to chassis module. <p>LISTENER:</p> <ul style="list-style-type: none"> • Reserved for future use. Do not select.

2.7.16 Second Control Interface

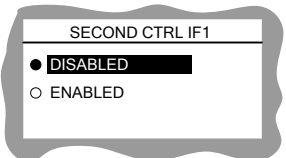
Display Contents	Description
 <p>The screenshot shows a menu titled "SECOND CTRL IF1". There are two options: "DISABLED" with a filled radio button and "ENABLED" with an empty radio button.</p>	<p>"SECOND CTRL IF1":</p> <ul style="list-style-type: none"> • Enables/disables the use of a second control head or service panel connected to IF1 interface. • Select function(s) required for the installation. • Use the rotary knob for selection. • Push the "STO" key to confirm. <p>DISABLED:</p> <ul style="list-style-type: none"> • Default setting. <p>ENABLED:</p> <ul style="list-style-type: none"> • Reserved for future use. Do not select.

2.8 Post Installation Check

After the device/system is installed completely do a test. Make sure that the compliance with the authority required procedures is obeyed.

The description that follows gives guidance for such tests.

2.8.1 Mechanical Installation and Wiring Check

- Make sure that all cables are attached and the shields are connected to ground.
- Examine the movement of controls to make sure that there is no interference.
- Make sure that all screws are tight and the connectors of the device are secured.

2.8.2 Power Supply

- Examine the power supply lines and the correct polarity.
- Make sure that the power supply is in the specified limits, with and without an engine that is in operation.

2.8.3 Activated Subsystems

- Examine all subsystems which were activated during installation setup: e.g. audio systems, transmission interfaces, etc.

2.8.4 Receiver Operation

- Make sure the proper reception of the COSPAS/SARSAT signal.
- It is recommended to use dedicated BT406 test setup for test signals in full permitted range. For minimal test use a PLB set in self-test mode (refer to the manual of the related PLB).

⚠ CAUTION

It is mandatory to follow all regulations regarding generation of RF COSPAS/SARSAT distress signals.

If a PLB is used as a source of a test signal, it is not permitted to activate it in live emergency mode.

- Each emergency call instantly triggers a search and rescue operation.
- Misuse is strenuously prosecuted and can incur claims for damages.
- Unauthorized persons may not operate the PLB.

2.8.5 Antenna Check

Refer to antenna manual.

2.8.6 Interference Check

- Examine the device/system while the engine is in operation and power-on all other avionics/ electrical systems on the aircraft, to make sure that no significant interference exists.
- Examine that the device does not cause significant interference with other systems.
- Do a check for interference between the VHF-COM and the GPS receiver used by BD406.
- Is the reception be influenced by local interference, trace the source by systematically power-off the electronic equipment, generators, etc. on the aircraft to find which component is causing interference. Then suppress interference accordingly.
- Typical sources of interference are: generators, regulators, static inverters, choppers, DC converters, RF sources: transponders, DME, communication equipment.

2.8.7 Flight Test Check

- It is recommended to do a flight test as final installation verification.
- The performance of the device may be examined by reception of a distress beacon at a range of at least 25 NM while maintaining an appropriate altitude and over all normal flight attitudes.
- Examine performance with usage of all required navigation and communication equipment installed and used during simulated rescue mission.

2.9 Troubleshooting

If you cannot correct the problem stop using the device(s) and contact authorized maintenance shop for assistance, please.

BD406 without control head:

To control and read the test results, status and messages an external control interface is required. In case of problems, an error notification can be read out through the external control interface.

Problem	Possible Causes	Proposed Solution
No active backlight.	Installation setup: <ul style="list-style-type: none"> • Wrong dimming input selected. • Dimming input set to NONE and brightness set to 0. 	Installation setup: <ul style="list-style-type: none"> • Select correct function(s) required for the installation.
ERR-12: GPS Communication Error.	Communication error with GPS receiver. Installation setup: <ul style="list-style-type: none"> • External GPS source selected with no external receiver. 	Installation setup: <ul style="list-style-type: none"> • Set internal GPS source and connect GPS antenna.
Supplied homing is unknown.	GPS source does not supply valid position.	<ul style="list-style-type: none"> • Examine if GPS receiver can hold position. • Examine GPS antenna.
Unexpected homing audio notification.	Wrong wiring of GPI_0.	<ul style="list-style-type: none"> • Examine wiring.
Control head in mission mode does not respond to user operation (disabled interface).	Installation setup: <ul style="list-style-type: none"> • CH CTRL CONFIG is set to LISTENER. 	Installation setup: <ul style="list-style-type: none"> • Set CH CTRL CONFIG to FULL.
Display shows warning or error.	Details "Warning and Failure Indications" page 86.	Details "Warning and Failure Indications" page 86.
Device does not receive beacons transmission.	<ul style="list-style-type: none"> • Invalid antenna installation. • Unknown source of interference. 	<ul style="list-style-type: none"> • Examine antenna installation. • Do interference Check see "Interference Check" page 71

2.10 Targets Status Protocol - IF3 Interface

This subchapter describes the broadcasting protocol of the IF3 interface of the BD406 device.

- The protocol is used for reporting status information about all targets stored in BD406 device.
- It uses unidirectional broadcasting transmission compliant with RS232.
- Only outgoing transmission from the BD406 IF3 interface is available (BD406 is a transmitter).
- It is recommended that the device which receives these packets (receiver) meets requirements from "Recommended Receiver Operation" page 80.

2.10.1 Term Definition

Term	Description
#TN	Maximal number of the supported beacons / NavPoints, equal to 49.
CDI To The Target	Angular difference between True Bearing and Device True Course Over Ground (result is always positive number in 0...360 degrees).
Data	Information transmitted from one device to another one.
Frame	Complete block of information (from protocol point of view).
Frame Header	Byte which specifies the type of data the incorporated in the frame and the frame type.
Frame ID	Identifier of the data incorporated in the frame.
Frame Length	Length of frame, in bytes.
Frame Type	Permits distinguishing of the QUERY / VALUE frames.
Invalid	Means that data are unknown or unreliable.
Message Counter	Number of messages received from single beacon (unique for each 15HexID).
Packet	Block of bytes for transmission single frame.
Packet CRC	Checksum which protects packet integrity.
Packet Header	First byte of the Packet.
Physical Frame	Constant length, constant duration sequence of bits transmitted by physical layer. This is minimal portion of the information transmitted by physical layer. Single physical frame can carry 8 bits of data (1 byte).
Protocol ID	Unique identifier of the protocol.
Receiver	Device which receives data.
Start Bit	First bit of physical frame.
Stop Bit	Last bit of physical frame.
Target	NavPoint or beacon.
Transmitter	Device which transmits data.
Valid	Means that data are reliable.
Value Block	Data part of the frame.

Table 1: Target Status Protocol - Term Definition

2.10.2 Physical Layer

This layer is responsible for data exchange in the physical channel.

2.10.2.1 Transmission Parameters

The data interchange between the devices takes place through an asynchronous serial communication interface.

Configurable parameters:

BD406 with control head		BD406 without control head	
Bit rate:	1200, 2400, 4800, 9600, 19 200 bps	Bit rate:	19 200 bps
Data length:	8 bits	Data length:	8 bits
Parity:	NONE, EVEN, ODD	Parity:	NONE
Stop bits:	1 / 2	Stop bits:	1

A physical frame consists of 10/11 bits:

BD406 with control head	BD406 without control head
Start bit (equal to logical 0)	
8 bits of data (least significant bit first)	
1 / 2 stop bit (equal to logical 1)	1 stop bit (equal to logical 1)
Idle state is equal to logical 1	
No handshaking lines are required	
Time from start bit beginning to the first stop bit beginning is equal to $9/(\text{bit rate})$	

Notice: Contact manufacturer for different transmission settings.

2.10.2.2 Bit Rate Tolerance for Exchanged Physical Frames

The transmitter sends data with a bit rate equal to its nominal value $\pm 1\%$.

The receiver accepts incoming data transmitted with bit rate equal to its nominal value $\pm 2\%$.

2.10.3 Communication Description

2.10.3.1 Packet Description

- All bytes have 8-bit data.
- Bits are numerated from 0 (bit 0 is least significant bit - LSB).
- Bytes are numerated from 0.
- Byte 0 is the first byte in the sequence.
- The smallest information interchanged through a physical channel is a byte.
- Bytes are grouped into blocks called packet.
- A packet can carry single frame from the transmission protocol.

Structure of a packet:

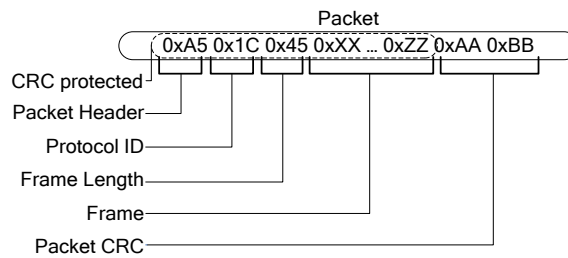

Figure 32: Target Status Protocol - Packet Description

Field	Length in bytes	Content
Packet Header	1	First byte of the packet. Packet always begins with packet header. Always equal to: 0xA5.
Protocol ID	1	Protocol identifier. Always equal to: 0x1C
Frame Length	1	Frame field length in bytes. Permitted value: 0x00..0xFF
Frame	up to 70	Frame contents. Permitted value for each byte: 0x00..0xFF
Packet CRC	2	Cyclic Redundancy Check (CRC) see "Packet CRC Definition" page 80. The packet CRC is transmitted with MSB first. It is used for packet integrity protection. Permitted value for each byte: 0x00..0xFF

Table 2: Target Status Protocol - Packet Description

2.10.3.2 Frame Description

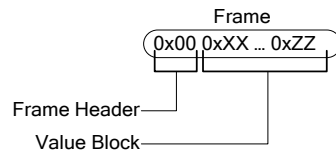

Figure 33: Target Status Protocol - Frame Description

Field	Length in bytes	Content
Frame Header	1	Bit 7: Set always to 0. Bits 6...0: Frame ID - identifies frame. Frame header is mandatory. Frame header is the first byte of the frame.
Value Block	up to 69	Specified for related frame ID. It identifies reported data, details see "Table 4: Target Status Protocol - Frame Content Description" page 79.

Table 3: Target Status Protocol - Frame Description

Frame Content Description

The table "Table 4: Target Status Protocol - Frame Content Description" page 79 contains detailed description of the protocol data.

Multi byte data are organized related to the big-endian order i.e. MSB first.

The term "string" shows sequence of bytes where its values are in [0x20 ... 0x7E] range (ASCII subset).

Table details:

- Name - name of the parameter / accessible status of the protocol.
- Frame ID – unique identifier of the frame, decimal (hex in parenthesis).
- Value block length – length of frame contents in bytes.

Description
<p>Name: Broadcasted Beacon Info; Frame ID: 0 (0x00); Value Block Length: 69 bytes</p> <p>Value Block:</p> <p>Byte 0: Index of the current Beacon. Range [0...#TN-1]. Unit: none (data type: 8-bit unsigned integer). 0xFF value denotes Invalid data.</p> <p>Byte 1: Total count of Beacons in the Beacons DB. Range [0...#TN]. Unit: none (data type: unsigned integer). If this byte is equal to 0x00 it means that all other bytes in this Frame are Invalid.</p> <p>Byte 2: Status byte:</p> <p>Bits 7...6: not used (always set to 0)</p> <p>Bit 5: (Self-Test Message) (0 - no self-test message, 1 – self-test message)</p> <p>Bit 4: Manual Offset included in True Beacon Position (0 – not not included, 1 - included, bit 2 and bit 3 cannot be set to 1 together)</p> <p>Bit 3: Auto Offset included in True Beacon Position (0 – not included, 1 – included, bit 2 and bit 3 cannot be set to 1 together)</p> <p>Bit 2: PDF-2 field valid (0 – field invalid, 1 – field valid)</p> <p>Bit 1: Distance unit of the Distance To The Target (0 – km, 1 – NM)</p> <p>Bit 0: True Beacons Longitude and True Beacons Latitude fields valid (0 – fields invalid, 1 – fields valid)</p>

Description
Name: Broadcasted Beacon Info; Frame ID: 0 (0x00); Value Block Length: 69 bytes
Bytes 3...18: Message contents. Raw sequence of the encoded bit stream – reflect bits 17...144 of Message. Data are left aligned (in case of short Message, the last 32 bits are set to 0xFFFFFFFF). Bit 17 of the Message is MSB bit of byte 3. Bit 144 of the Message is LSb bit of byte 18.
Bytes 19...26: 15HexID. Right aligned data (4 most significant bits of byte 19 always equal to 0).
Byte 27: Year of First Message Detection Time: Range [0 ... 99] plus 0xFF. Unit: [1 Year] (data type: unsigned integer). Value equal to 0xFF denotes Invalid value. Value reported in this byte includes UTC Offset.
Byte 28: Month of First Message Detection Time: Range [1 ... 12] plus 0xFF. Unit: [1 Month] (data type: unsigned integer). Value equal to 0xFF denotes Invalid value. Value reported in this byte includes UTC Offset.
Byte 29: Day of First Message Detection Time: Range [1 ... 31] plus 0xFF. Unit: [1 Day] (data type: unsigned integer). Value equal to 0xFF denotes Invalid value. Value reported in this byte includes UTC Offset.
Byte 30: Hours of First Message Detection Time: Range [0 ... 23] plus 0xFF. Unit: [1 Hour] (data type: unsigned integer). Value equal to 0xFF denotes Invalid value. Value reported in this byte includes UTC Offset.
Byte 31: Minutes of First Message Detection Time: Range [0 ... 59] plus 0xFF. Unit: [1 Minute] (data type: unsigned integer). Value equal to 0xFF denotes Invalid value. Value reported in this byte includes UTC Offset.
Byte 32: Seconds of First Message Detection Time: Range [0 ... 59] plus 0xFF. Unit: [1 Second] (data type: unsigned integer). Value equal to 0xFF denotes Invalid value.
Byte 33: Year of Last Message Detection Time: Range [0 ... 99] plus 0xFF. Unit: [1 Year] (data type: unsigned integer). Value equal to 0xFF denotes Invalid value. Value reported in this byte includes UTC Offset.
Byte 34: Month of Last Message Detection Time: Range [1 ... 12] plus 0xFF. Unit: [1 Month] (data type: unsigned integer). Value equal to 0xFF denotes Invalid value. Value reported in this byte includes UTC Offset.
Byte 35: Days of Last Message Detection Time: Range [1 ... 31] plus 0xFF. Unit: [1 Day] (data type: unsigned integer). Value equal to 0xFF denotes Invalid value. Value reported in this byte includes UTC Offset.
Byte 36: Hours of Last Message Detection Time: Range [0 ... 23] plus 0xFF. Unit: [1 Hour] (data type: unsigned integer). Value equal to 0xFF denotes Invalid value. Value reported in this byte includes UTC Offset.
Byte 37: Minutes of Last Message Detection Time: Range [0 ... 59] plus 0xFF. Unit: [1 Minute] (data type: unsigned integer). Value equal to 0xFF denotes Invalid value. Value reported in this byte includes UTC Offset.
Byte 38: Seconds of Last Message Detection Time: Range [0 ... 59] plus 0xFF. Unit: [1 Second] (data type: unsigned integer). Value equal to 0xFF denotes Invalid value.
Bytes 39...42: True Beacon Latitude: Range [-90.0 ... 90.0]. Unit: [1 degree] (data type: 32 bits floating point). Negative value means south, otherwise north.
Bytes 43...46: True Beacon Longitude: Range [-180.0 ... 180.0]. Unit: [1 degree] (data type: 32 bits floating point). Negative value means west, otherwise east.
Bytes 47...48: Difference between Message Frequency and 406.050 MHz. Range [-30000 ... 31000]. Unit: [Hz] (data type: signed integer, code U2). Value -30000 means that Message Frequency is equal to 406.020 MHz.
Byte 49: Signal Strength of Message: Range [-150 ... 104]. Unit: [dBm] (data type: unsigned integer, code U2). Value 0 corresponds to -150 dBm, value 150 corresponds to 0 dBm, value 254 corresponds to 104 dBm. Value 255 (0xFF) denotes invalid data.

Description
Name: Broadcasted Beacon Info; Frame ID: 0 (0x00); Value Block Length: 69 bytes
Bytes 50...51: Message Counter, Range [0...65535]. Unit: none (data type: unsigned integer). Value equal to 0xFFFF denotes Invalid value.
Bytes 52...53: True Bearing, Range [0...3599] plus 0xFFFF. Unit: [0.1 degree] (data type: unsigned integer). Value equal to 0xFFFF denotes Invalid value.
Bytes 54...55: Distance To The Target, Range [0...9999] plus 0xFFFF. Unit: [0.1 distance unit] (distance unit is defined in byte 2) (data type: unsigned integer). Value equal to 0xFFFF denotes Invalid value.
Bytes 56...57: CDI To The Target, Range [0...3599] plus 0xFFFF. Unit: [0.1 degree] (data type: unsigned integer). Value equal to 0xFFFF denotes Invalid value.
Byte 58: Hours of EET: Range [0 ... 23] plus 0xFF. Unit: [1 Hour] (data type: unsigned integer). Value equal to 0xFF denotes Invalid value.
Byte 59: Minutes of EET: Range [0 ... 59] plus 0xFF. Unit: [1 Minute] (data type: unsigned integer). Value equal to 0xFF denotes Invalid value.
Byte 60: Seconds of EET: Range [0 ... 59] plus 0xFF. Unit: [1 Second] (data type: unsigned integer). Value equal to 0xFF denotes Invalid value.
Byte 61: Hours of ETA: Range [0 ... 23] plus 0xFF. Unit: [1 Hour] (data type: unsigned integer). Value equal to 0xFF denotes Invalid value. Value reported in this byte includes UTC Offset.
Byte 62: Minutes of ETA: Range [0 ... 59] plus 0xFF. Unit: [1 Minute] (data type: unsigned integer). Value equal to 0xFF denotes Invalid value. Value reported in this byte includes UTC Offset.
Byte 63: Seconds of ETA: Range [0 ... 59] plus 0xFF. Unit: [1 Second] (data type: unsigned integer). Value equal to 0xFF denotes Invalid value.
Bytes 64...65: Country code of the Beacon: Range [0 ... 999] plus 0xFFFF. Unit: none (data type: unsigned integer). Value equal to 0xFFFF denotes Invalid value.
Byte 66: Beacon Type and Protocol Type: <ul style="list-style-type: none"> • Bits 7...4: Beacon Type: Interpretation of encoded values: <ul style="list-style-type: none"> ○ 0 – ELT ○ 1 – PLB ○ 2 – EPIRB ○ 3 – SSAS ○ 4 – TEST ○ 5...14 – not used ○ 15 – denotes Invalid data • Bits 3...0: Protocol Type: Interpretation of encoded values: <ul style="list-style-type: none"> ○ 0 – STD-LOC ○ 1 – NAT-LOC ○ 2 – USER ○ 3 – USER-LOC ○ 4...14 – not used ○ 15 – denotes Invalid data
Bytes 67...68: Beacon Serial Number: Range [1 ... 16383] plus 0xFFFF. Unit: none (data type: unsigned integer). Value equal to 0xFFFF denotes Invalid value.

Description
<p>Name: Broadcasted NavPoint Info; Frame ID: 1 (0x01); Value Block Length: 53 bytes</p> <p>Value Block:</p> <p>Byte 0: Index of the current NavPoint. Range [0...#TN-1]. Unit: none (data type: 8-bit unsigned integer). 0xFF value denotes Invalid data.</p> <p>Byte 1: Total count of NavPoints in the NavPoints DB. Range [0...#TN]. Unit: none (data type: unsigned integer). If this byte is equal to 0x00 it means that all other bytes in this Frame are Invalid.</p> <p>Byte 2: Status byte:</p> <ul style="list-style-type: none"> • Bits 7...2: not used (always set to 0) • Bit 1: Distance unit of the Distance To The Target (0 – km, 1 – NM) • Bit 0: NavPoint Longitude and NavPoint Latitude fields valid (0 – fields invalid, 1 – fields Valid) <p>Bytes 3...12: NavPoint Name contents. String of following ASCII characters: 'space', '-', '.', '/', '0'...'9', 'A'...'Z'. Left aligned data. Unused bytes are filled with 0x00.</p> <p>Bytes 13...32: NavPoint Info. String of following ASCII characters: 'space', '-', '.', '/', '0'...'9', 'A'...'Z'. Left aligned data. Unused bytes are filled with 0x00.</p> <p>Bytes 33...36: NavPoint Latitude: Range [-90.0 ... 90.0]. Unit: [1 degree] (data type: 32 bits floating point). Negative value means south, otherwise north.</p> <p>Bytes 37...40: NavPoint Longitude: Range [-180.0 ... 180.0]. Unit: [1 degree] (data type: 32 bits floating point). Negative value means west, otherwise east.</p> <p>Bytes 41...42: True Bearing, Range [0...3599] plus 0xFFFF. Unit: [0.1 degree] (data type: unsigned integer). Value equal to 0xFFFF denotes Invalid value.</p> <p>Bytes 43...44: Distance To The Target, Range [0...9999] plus 0xFFFF. Unit: [0.1 distance unit] (distance unit is defined in byte 2) (data type: unsigned integer). Value equal to 0xFFFF denotes Invalid value.</p> <p>Bytes 45...46: CDI To The Target, Range [0...3599] plus 0xFFFF. Unit: [0.1 degree] (data type: unsigned integer). Value equal to 0xFFFF denotes Invalid value.</p> <p>Byte 47: Hours of EET: Range [0 ... 23] plus 0xFF. Unit: [1 Hour] (data type: unsigned integer). Value equal to 0xFF denotes Invalid value.</p> <p>Byte 48: Minutes of EET: Range [0 ... 59] plus 0xFF. Unit: [1 Minute] (data type: unsigned integer). Value equal to 0xFF denotes Invalid value.</p> <p>Byte 49: Seconds of EET: Range [0 ... 59] plus 0xFF. Unit: [1 Second] (data type: unsigned integer). Value equal to 0xFF denotes Invalid value.</p> <p>Byte 50: Hours of ETA: Range [0 ... 23] plus 0xFF. Unit: [1 Hour] (data type: unsigned integer). Value equal to 0xFF denotes Invalid value. Value reported in this byte includes UTC Offset.</p> <p>Byte 51: Minutes of ETA: Range [0 ... 59] plus 0xFF. Unit: [1 Minute] (data type: unsigned integer). Value equal to 0xFF denotes Invalid value. Value reported in this byte includes UTC Offset.</p> <p>Byte 52: Seconds of ETA: Range [0 ... 59] plus 0xFF. Unit: [1 Second] (data type: unsigned integer). Value equal to 0xFF denotes Invalid value.</p>

Table 4: Target Status Protocol - Frame Content Description

2.10.3.3 Packet Broadcasting

- The transmitter sends first one by one the status of all existing beacons (frame ID 0x00) and then one by one the status of all existing NavPoints (frame ID 0x01).
- The transmitter repeats this process continuously.
- The more beacons and NavPoint in databases the more data are transmitted.
- When none beacons and none NavPoints are in memory - empty frames with byte 1 equal 0 are shown.

2.10.3.4 Packet CRC Definition

- Packet CRC shall be calculated using 16-bit binary polynomial represented by number 0x8005 (known as CRC-16).
- Packet CRC shall be calculated from sequence of bits consisting of packet header, protocol ID, frame length and frame.
- Bits shall be inserted for packet CRC calculation starting from the MSB of the packet header.

Examples of calculated checksums:

- Input: 0x0000 result: 0x0000
- Input: 0x0001 result: 0x8005
- Input: 0x0001 0x8005 result: 0x0000
- Input: 0xFFFF result: 0x800D
- Input: 0xA514 0x0120 result: 0x43E3

2.10.3.5 Maximal Duration of the Transmitted Packet

Duration of outgoing packet is no longer than twice the minimum time required for packet transmission:

$$[\text{Max packet duration}] \leq 20 * [1/\text{bit rate}] * [\text{number of bytes in the packet}]$$

2.10.4 Recommended Receiver Operation

2.10.4.1 Incoming Packet

- The receiver scans for the packet header, record the packet and verify the packet CRC.
- Packets with incorrect CRC will be rejected.

Packet is valid if:

- Frame ID is correct for protocol ID extracted from packet and
- The length of the received frame is correct.
Otherwise the frame is invalid. Invalid frames will be ignored.

2.10.4.2 Length of the Longest Supported Packet

The receiver can work with packets which length is not larger than 75 bytes.

3 Operation

In this chapter you can read about:

3.1	General.....	81
3.2	Device Description	81
3.3	Controls and Indications.....	82
3.3.1	User Interface - BD406	82
3.3.2	Symbols on the BD406 Display	83
3.3.3	User Interface - PBD406.....	84
3.3.3.1	Recommendations:.....	84
3.3.4	Audio Notification.....	85
3.3.5	Warning and Failure Indications	86
3.3.6	Power Interrupt Indication.....	88
3.4	Operation Modes.....	88
3.5	Start-Up - BD406 with Control Head.....	89
3.6	Start-Up - BD406 without Control Head.....	90
3.6.1	Operation with other Controller.....	90
3.7	Start-Up - PBD406	90
3.8	Mission Mode	91
3.8.1	Terms and Definitions	91
3.8.2	Course Deviation Indicator (CDI) – Beacon/NavPoint detailed Menu	94
3.8.3	Course Deviation Indicator (CDI) – Beacon/NavPoint Course View	95
3.8.4	Mission Mode - Menu Structure.....	96
3.8.5	Operations from Beacons/NavPoints Details View.....	97
3.8.6	Operations from Beacons/NavPoints Menu View.....	101
3.8.7	Operations from Config Menu View.....	103
3.8.8	Operations from Beacon/NavPoint Course View.....	105
3.9	GPS Status View.....	106
3.10	Receive Operation – Message Detection	107
3.11	Contact Data	109

3.1 General

This section contains general information and instructions for safe operation.

3.2 Device Description

The COSPAS/SARSAT Beacon Decoder BD406 and PBD406 are made for use by search and rescue (SAR) authorities as a tool to receive vital information and assistance during rescue missions.

- The BD406 is a single block device made for installations in fixed and rotary wing aircraft.
- The BD406 without control head is a single block remote controlled device made for installations in fixed and rotary wing aircraft.
 - It does not have a user interface or display (remote controlled).
- The PBD406 is a portable version of the BD406 with built-in battery and housing.

Any use in different applications or combination with other equipment must be approved by Becker Avionics.

3.3 Controls and Indications

BD406 without control head:

N/A.

3.3.1 User Interface - BD406

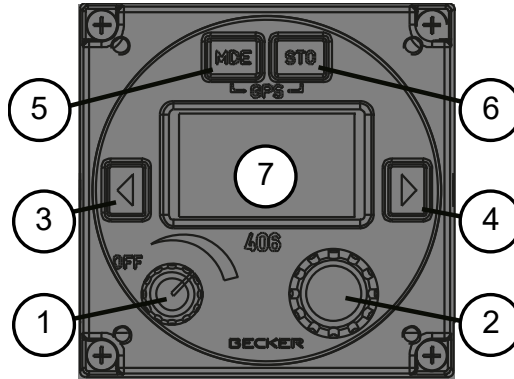

Figure 34: User Interface - BD406*

* BD406 is part of the PBD406





	Symbol	Description	Main Function
1		Power ON/OFF, volume	<ul style="list-style-type: none"> • Turns the device ON/OFF and is used to adjust the volume level of audio output signals.
2		Rotary knob with push button function Context sensitive element.	<ul style="list-style-type: none"> • Turn the rotary encoder to change the selected parameters (decrease/increase values, ...). • Push the rotary encoder to select the digits. • Push the rotary knob activates voice messages. • Push the rotary encoder to confirm the adjustment.
3		Left key (abbrev. LEXCH) Context sensitive element.	<ul style="list-style-type: none"> • Short push – selects previous screen with beacon / NavPoint details (loop function).
4		Right key (abbrev. REXCH) Context sensitive element.	<ul style="list-style-type: none"> • Short push – selects next screen with beacon / NavPoint details (loop function).
5		Mode key Context sensitive element.	<ul style="list-style-type: none"> • Short push – toggles between beacon details and NavPoint details. • Long push – conditionally enters beacon menu / NavPoint menu (action can be ignored in specific mode).
6		Store key Context sensitive element.	<ul style="list-style-type: none"> • Short push – enters beacon course / NavPoint course. • Long push – enters config view.
	-GPS-		<ul style="list-style-type: none"> • Push and hold the MDE and STO key at the same time for > 2 s to activate the GPS mode.
7		LCD: Liquid Crystal Display	<ul style="list-style-type: none"> • Shows context dependent contents.

The device identifies a:

"Long push": when you push and hold down a knob or key for > 2 seconds.

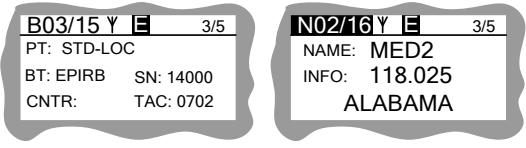
"Short push": any push < 2 seconds.

3.3.2 Symbols on the BD406 Display

Symbol	Description
<p>Examples:</p>  <p>Figure 35: LCD - View during Mission</p>	<p>Possible display views during mission.</p>
 <p>Figure 36: LCD - Status Bar</p>	<p>Status bar: The status bar is context dependent. It is always shown.</p> <p>BXX/YY ANT(or GPSFIX) E O VV/ZZ</p>
<p>BXX/YY or NXX/YY</p>	<p>B: Beacon N: NavPoint XX current element index in beacons DB / NavPoints DB, or -- double dash if related beacons DB / NavPoints DB is empty. YY total number of stored items in beacons DB / NavPoints DB, -- double dash if related beacons DB / NavPoints DB is empty.</p>
<p>Y</p>	<p>Antenna icon, conditionally shown when valid COSPAS/SARSAT message is received.</p>
	<p>Error icon, conditionally shown when error occurs.</p>
	<p>GPS fix icon, conditionally shown if antenna not available. Icon in view when GPS receiver supplies a valid position data.</p>
<p>VV/ZZ</p>	<p>VV: current index page in view. ZZ: total number pages in view.</p>

Notice:

BXX/YY is not inverted (black letters, transparent background) if beacon details view is active.
NXX/YY is inverted (transparent letters, black background) if NavPoint details view is active.

3.3.3 User Interface - PBD406

BD406 is part of the portable version PBD406. PBD406 has the same set of controls as BD406 control head plus elements on the front panel of the housing.

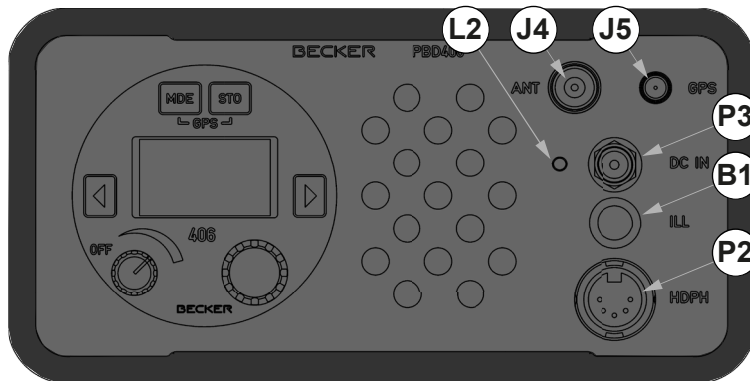

Figure 37: User Interface - PBD406

	Description	Main Function
J4	406 MHz antenna connector	406 MHz antenna.
J5	GPS antenna connector	GPS antenna.
P3	External DC voltage	Connector P3 for external power supply.
P2	Headphone / speaker output	Connector P2 is internally connected to the related pins of BD406 P1 connector.
B1	Illumination button	Push to set on screen backlight for approx. 15 s.
L2	LED	External voltage indicator.
..	Speaker	Speaker

3.3.3.1 Recommendations:

The portable UHF 406 MHz antenna has a fixture to attach the antenna to any object that extends PBD406 reception range during a rescue mission (a mast, etc.). The antenna can be also held in hand (near BNC connector) however this can decrease the effective range of a signal reception.

PBD406 has a dedicated GPS antenna. It must be connected directly to the SMA socket J5.

⚠ CAUTION

- Connect active GPS antenna to the BD406/PBD406 only when the device is **not** powered-on.
 - Do not connect or disconnect the GPS antenna when the BD406/PBD406 operates, as the internal GPS receiver calibrates the noise floor on power-up.
 - To connect the antenna after power-up can cause an extended acquisition time.
- The GPS antenna must have direct view to sky to maximize its effectiveness.
 - It must not be covered by any objects, as it degrades quality and reliability of the fixed position.
 - Any obstruction near the GPS antenna can cause significant reduction of the precision. Interference obstacles are e.g.: buildings, trees, fences, cables etc.
 - Obstructions can have an effect that the receiver receives a decreased number of satellites and that the strength of satellite geometry is decreased (high PDOP values).

3.3.4 Audio Notification

BD406 without control head:

N/A.

- BD406/PBD406 can supply voice notifications to speaker or headphones. Audio messages are supplied on demand or in case of special event which occurs in the system.
- The operator is notified about device malfunctions or when signal from distress beacon is detected.

Spoken Phrase	Description
Zero	Message supplied when digit 0 is reported.
One	Message supplied when digit 1 is reported.
Two	Message supplied when digit 2 is reported.
Three	Message supplied when digit 3 is reported.
Four	Message supplied when digit 4 is reported.
Five	Message supplied when digit 5 is reported.
Six	Message supplied when digit 6 is reported.
Seven	Message supplied when digit 7 is reported.
Eight	Message supplied when digit 8 is reported.
Nine	Message supplied when digit 9 is reported.
Dot	Message supplied when the dot separator is reported.
Beacon	Message supplied when signal from beacon, which is already registered in internal memory, is received.
New Beacon	Message supplied when signal from beacon, which is not registered in internal memory, is received.
Degrees	Message supplied when the degree value is reported.
Distance	Message supplied when the distance to the target is reported.
Kilometers	Message supplied when the kilometer value is reported.
Miles	Message supplied when the nautical mile value is reported.
Beacon Decoder Failure	Message supplied when error is found during PBIT.
True Bearing	Message supplied when true bearing is necessary.
Unknown	Message supplied when reported value is unknown.
	<p>Message called homing. It contains phrase: "True bearing: XXX degrees. Distance XXX.X kilometers (miles)."</p> <p>Example of a spoken message: "True bearing: Two, three, five degrees. Distance: One eight nine dot four kilometers."</p> <ul style="list-style-type: none"> • When distance is set to nautical miles word kilometers is replaced with miles. • When distance/true bearing are not valid the device announces: <ul style="list-style-type: none"> ○ "True Bearing: Unknown. Distance: Unknown." ○ Homing message is triggered by push rotary knob (depends on configuration).

3.3.5 Warning and Failure Indications

BD406 / PBD406 supply additional information about existing or occurred malfunctions. Not all abnormal situations can be shown to the user, but the device will try to show scope of error.

The device tests itself during test called PBIT. The test works during each power-on process. The receiver shows error screen with information about total number of errors that were registered in the system, number of current errors, error identifier (Error ID), short description, user action – if available. If error messages cannot be removed from the screen contact service.

Action, related to errors that can be confirmed by the user, it depends on malfunction.

BD406 without control head:

To control and read the test results, status and messages an external control interface is required.

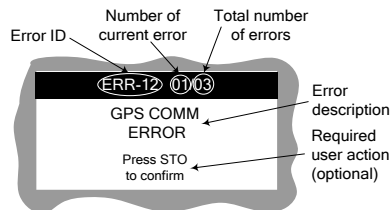
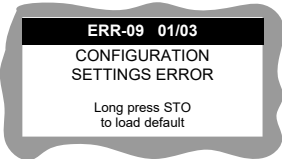

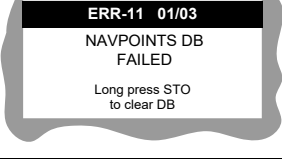
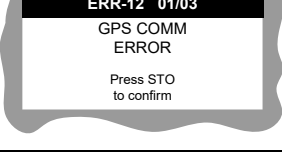

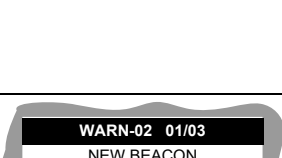
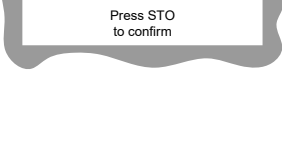

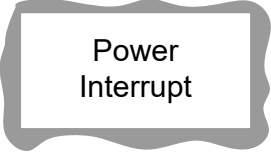

Figure 38: Error/Warning - Display Description

Error ID	Display	Description/Action
1		<ul style="list-style-type: none"> • All internal installation settings are lost. • Contact service.
2		<ul style="list-style-type: none"> • Calibration / factory settings are lost. • Contact service.
3		<ul style="list-style-type: none"> • Communication error between CH and CM. • Contact service.
4		<ul style="list-style-type: none"> • CM hardware error. • Contact service.
5		<ul style="list-style-type: none"> • Beacons database integrity error. • Data are lost. • Contact service.
8		<ul style="list-style-type: none"> • Audio database integrity error. • Data are lost. • Contact service.

Error ID	Display	Description/Action
9		<ul style="list-style-type: none"> • Integrity of configuration settings is compromised. • Data are lost. • Contact service.
10		<ul style="list-style-type: none"> • Operation data integrity error. • Data are lost. • Contact service.
11		<ul style="list-style-type: none"> • NavPoint database integrity error. • Data are lost. • Contact service.
12		<ul style="list-style-type: none"> • GPS communication is lost. Internal or external GPS receiver does not supply valid transmission. Make sure that correct source is selected in installation setup. • Contact service.
WARN-01		<p>Warning is shown:</p> <ul style="list-style-type: none"> • In installation setup at FULL DB CONF screen STORE NEW BEACON is selected. <p>AND</p> <ul style="list-style-type: none"> • Database is full. <p>AND</p> <ul style="list-style-type: none"> • New message from unregistered in database beacon is received by the device. • Push STO to confirm.
WARN-02		<p>Warning is shown:</p> <ul style="list-style-type: none"> • If in installation setup at FULL DB CONF screen IGNORE NEW BEACON is selected. <p>AND</p> <ul style="list-style-type: none"> • Database is full. <p>AND</p> <ul style="list-style-type: none"> • A new message from unregistered in database beacon is received by the device. • Push STO to confirm.
-		<p>Warning is shown:</p> <ul style="list-style-type: none"> • When a new message from not registered in database beacon is received. • Push STO to confirm.
-		<ul style="list-style-type: none"> • Shown only in installation setup when CH or CM installation data are corrupted (CRC error occurs). • Contact service.

3.3.6 Power Interrupt Indication

	Display	Description/Action
		<ul style="list-style-type: none"> • Message to the user about power supply malfunction (depends on configuration). • Do a check of the installation wiring and power supply conditions.

3.4 Operation Modes

BD406 can work in two different modes.

Installation Mode:

- The installation mode is for qualified ground technicians to set the equipment in an aircraft and must not be used in flight (see installation manual for details).

Mission Mode:

- The mission mode is for typical rescue mission see "Mission Mode" page 91.

Notice - BD406 without control head:

These operation modes are not applicable.

To control and read the test results, status and messages an external control interface is required.

3.5 Start-Up - BD406 with Control Head

NOTICE Excessive pulses on the DC bus of the aircraft may cause damage on electrical circuits of any installed instrument.
Do not power-on the device during engine start or shutdown.

- Turn the volume knob clockwise to turn on the device.
- After power-on, the device starts a self-test (PBIT).
- The display shows the serial number (S/N) of the device, the software version of control head (CH) and the software version of chassis module (CM).



Figure 39: Start-Up View

- If there is an error the display shows an error message.



Figure 40: Error Messages

Some error messages can be confirmed by the user, then an additional notification is shown:

"Press STO to confirm"

or

"Long press STO to clear...".

- When the error is reset the device continues with the next menu, user has knowledge about possible malfunctions and its consequences.
- In cases where error cannot reset – device tries to show information about malfunction, but regular operation is stopped - please contact service facility.
- If there is no error the device starts with screen:



Figure 41: Operation - Clear Results ...

When this request is confirmed, BD406 starts in Beacon/NavPoint details view.

The device changes to and restores the last screen with a view of beacon or NavPoint details.

Short push to left key:

- Beacon database will be erased, no screen content and receiver continue operation.

Short push to right key:

- No screen content and receiver continue operation without previously stored data.

3.6 Start-Up - BD406 without Control Head

NOTICE

The BD406 without control head has no display and no on/off switch. The start-up of the device depends on installation. It can be an external switch to power-on the device or a permanent connection of the dedicated pins.

- After power-on, the device starts a self-test (PBIT).
- The device resets the beacon database.
- The device activates target status interface and is ready to detect distress signals.
 - Status of received distress messages can be monitored by serial target status interface.
 - The received messages and processed additional data are visible continuously as broadcasted frames.
 - When a new message is received, after integrity check, the content is presented at target status interface.

NOTICE

Each restart (power-on/off) of the remote-controlled BD406 results in automatic reset of the beacon database. All received distress messages are erased from memory.

BD406 without control head Target Status Protocol Default Configuration	
Bit rate:	19 200 bps
Data length:	8 bits
Parity:	NONE
Stop bits:	1

Table 5: BD406 without Control Head - Target Status Protocol Default Configuration

Notice: Contact manufacturer for changes in the target status communication parameters

3.6.1 Operation with other Controller

For detailed information refer to the manual of the respective product.

3.7 Start-Up - PBD406

- Connect antennas and headphones to the related jacks.
- Turn the volume knob clockwise to turn on the device.
- Push the ILL key to illuminate the LCD screen.
- Go to start-up instructions for BD406 with control head for further instructions.

3.8 Mission Mode

Mission Mode is used during rescue mission.

- The mode has access to all vital data received from rescue beacon and calculates mission related data.
- The device decodes COSPAS/SARSAT message and supply it in several formats.
- Beacon data can be defined by its protocol type, beacon type, beacon number, TAC (Type Approval Certificate) number, country code, raw 15HexID.
- The device can also decode and supply user formats. For details on definitions refer to documents published by COSPAS – SARSAT organization (<http://www.cospas-sarsat.org/en/cospas-sarsat-documentation>).
- The device calculates navigation parameters that can be dynamically refreshed during mission.

BD406 without control head:

N/A.

3.8.1 Terms and Definitions

Term	Description
15HexID	Unique identifier of the beacon (refer to COSPAS/SARSAT documentation)
Active	Active state related to the pin, signal, functionality, etc.
Audio DB	Database of Audio Messages which may be played by the device.
Audio Message	Single audio message played by the device
Beacon	The source of the 406 MHz emergency transmissions
Beacon Record	Beacons DB item intended for storing data concerning single beacon
Beacon Serial Number	Denotes unique identification of the beacon.
Beacon Type	The type of the beacon (ELT, PLB, EPIRB, SSAS, TEST for definitions refer to COSPAS/SARSAT documentation)
Beacon's First Message Date	Device UTC Date when the first message from the unique beacon was received
Beacon's First Message Time	Device UTC Time when the first message from the unique beacon was received
Beacon's Last Message Date	Device UTC Date when the last message from the unique beacon was received
Beacon's Last Message Time	Device UTC Time when the last message from the unique beacon was received
Beacons DB	Database containing list of detected Beacons
CDI	Course Deviation Indicator / Indication. It may be expressed in angular or distance units. Details "Course Deviation Indicator (CDI) – Beacon/NavPoint detailed Menu" page 94 and "Course Deviation Indicator (CDI) – Beacon/NavPoint Course View" page 95.
CH	Control head module of the device
CM	Core module (chassis module) of the device
Constant Course	Course (related to the true north) to the target that is set by user in range 0..359 degrees
Device	BD406 / PBD406
Device Altitude	The altitude received by the device from external/internal GPS receiver.
Device Latitude	Latitude of the device received by device from external/internal GPS. Valid/invalid status is an integral part of this data.
Device Longitude	Longitude of the device received by the device from external/internal GPS. Valid/invalid status is an integral part of this data.

Term	Description
Device PDOP	Positional Dilution Of Precision received by the device from external/internal GPS
Device Position	Position of the device decoded from internal/external GPS, consisting of device latitude and device longitude.
Device Serial Number	Serial number of the device
Device Speed Over Ground	Speed over ground of the device received by device from external/internal GPS
Device True Course Over Ground	True course of the device received by device from external/internal GPS
Device UTC Date	UTC date received by device from external/internal GPS. Valid/invalid status is an integral part of this data.
Device UTC Time	UTC time received by device from external/internal GPS. Valid/invalid status is an integral part of this data.
Distance To The Target	Distance between device position and target position
ETA	Estimated Time Of Arrival to the Target
First Message Detection Time	Time when the first message for the specified beacon was detected
Fixed Position	Device position stored in internal memory. It is used as a reference position to calculate course deviations parameters. Fixed position is updated when rotary knob is long pushed. Details "Figure 42: Mission Mode - CDI, Angular Definition for Fixed Position in Beacon/NavPoint detailed Menu" page 94.
Fixed Position To Target Course	Course (related to the true north) from fixed position to target position. Range: [0...360 degrees]
Inactive	Inactive state related to the pin, signal, functionality, etc.
Installation Setup	The way of equipment configuration available for the end-user in special installation mode
Invalid	Means that data are not reliable or unknown
Last Message Detection Time	Time when the last message for the specified beacon was detected
Message	406 MHz distress message transmitted by the beacon
Message Counter	Number of messages received from single beacon (unique for each 15HexID)
Message Frequency	Carrier frequency of the detected message
NavPoint Info	Short text information which may be assigned to the NavPoint
NavPoint Latitude	Latitude of the NavPoint
NavPoint Longitude	Longitude of the NavPoint
NavPoint Name	Short name of the NavPoint
NavPoint Position	Position assigned to the NavPoint, consists of NavPoint Latitude and NavPoint Longitude.
NavPoint Record	Single record in NavPoints DB. Navigation points are auxiliary points the device user can navigate to.
NavPoints DB	Set of NavPoints stored in the device.
Panel Controls	Push keys and rotary knob on the CH front side
PBIT	Test procedure which checks main functionality of the device
Protocol Type	The type of the protocol transmitted by the Beacon
Self-Test Message	Distress message transmitted by the beacon in self-test mode (refer to COSPAS/SARSAT documentation)
Service Mode	Mode of the device operation dedicated for development/factory departments.

Term	Description
TAC	Type Approval Certificate Number. The TAC number is a unique number assigned by the COSPAS/SARSAT Secretariat to each beacon model which has been successfully tested in accordance with the COSPAS/SARSAT Type Approval Standard (C/S T.007)
Target	NavPoint or Beacon, depending on what is visible on the device display.
Target Position	Beacon or NavPoint Position (latitude, longitude)
Targets Status	Information outgoing of the device (available on IF3 interface), contains status of all detected Beacons and NavPoints.
TO/FROM	Direction indicator for CDI. Allowed values: TO: shows that target is not passed (pictogram: ▲) FROM: shows that target is passed (pictogram: ▼) UNKNOWN: no pictogram assigned to this value.
True Bearing	Course (related to the true north) from device position to target position. Range: [0...360] degrees.
UTC Offset	Enables the indication of time and date compliant with the current time zone.
Valid	Means that data are reliable

Table 6: Mission Mode - Term and Definitions

3.8.2 Course Deviation Indicator (CDI) – Beacon/NavPoint detailed Menu

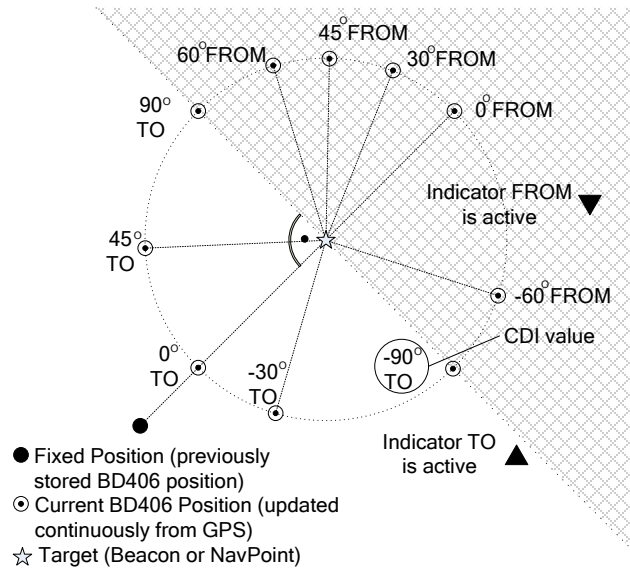

Figure 42: Mission Mode - CDI, Angular Definition for Fixed Position in Beacon/NavPoint detailed Menu

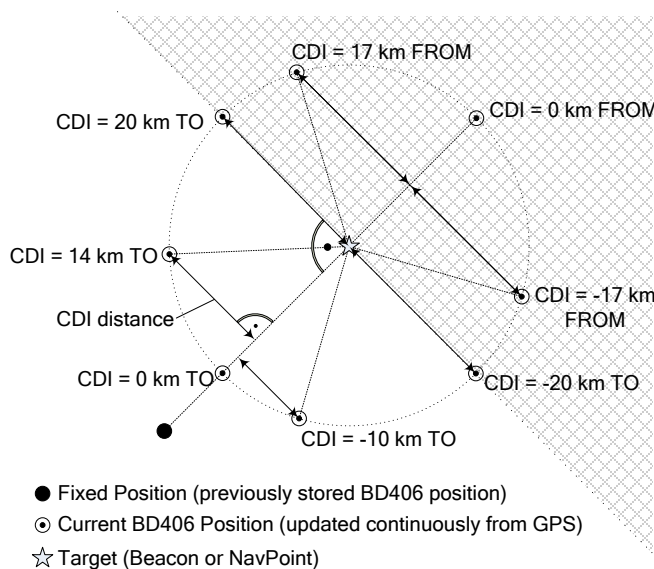

Figure 43: Mission Mode - CDI, Distance Definition for Fixed Position in Beacon/NavPoint detailed Menu

Course Deviation Indicator (CDI) in Beacon/NavPoint detailed menu shows angular difference between two courses:

- Defined between coordinates of fixed position and coordinates of the target (beacon or NavPoint).
- Current coordinates of the device and coordinates of the target.

CDI belongs to range [-90, 90] deg. details see "Figure 42: Mission Mode - CDI, Angular Definition for Fixed Position in Beacon/NavPoint detailed Menu" page 94.

Indications are not related to the device velocity – only position is in the account.

CDI shows valid values only if target and GPS source supply valid data. If CDI value is valid – a value of deviation can be calculated in kilometer or nautical miles, details see "Figure 43: Mission Mode - CDI, Distance Definition for Fixed Position in Beacon/NavPoint detailed Menu" page 94.

3.8.3 Course Deviation Indicator (CDI) – Beacon/NavPoint Course View

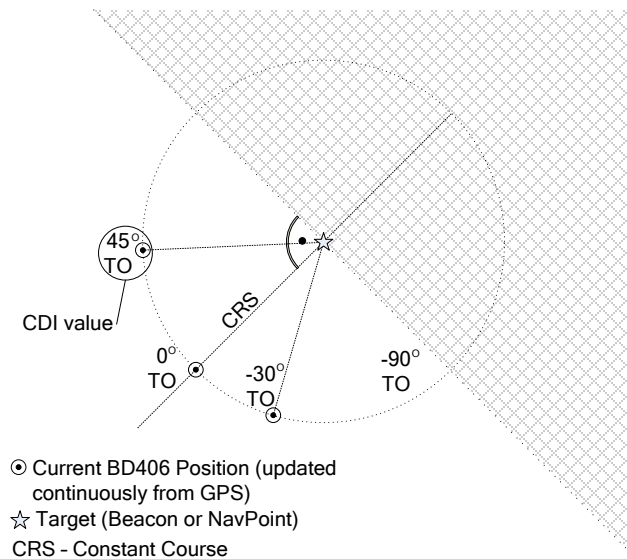

Figure 44: Mission Mode - CDI, Angular Mode, Definition for Constant Course (CRS) in Beacon/NavPoint Course View

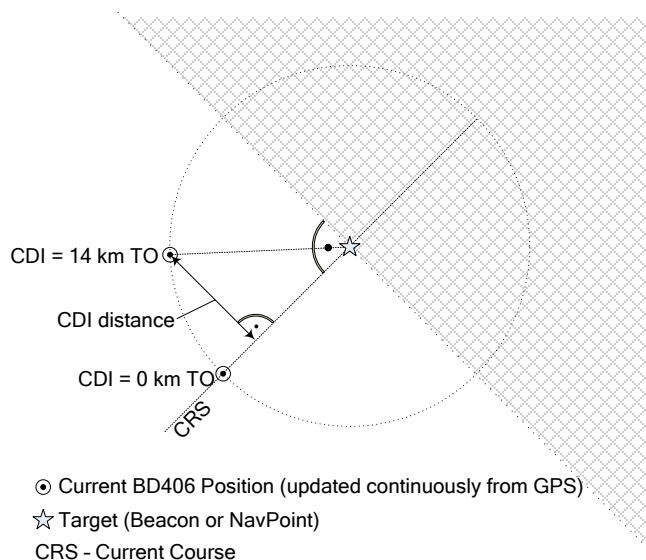

Figure 45: Mission Mode - CDI, Distance Mode, Definition for Constant Course (CRS) in Beacon/NavPoint Course View

Course Deviation Indicator (CDI) in Beacon/NavPoint constant course view shows angular difference between:

- Constant Course (CRS) - set course with rotary knob (in range 0...359 degrees).
- True bearing

In angular mode CDI belongs to range [-90, 90] deg. details see "Figure 44: Mission Mode - CDI, Angular Mode, Definition for Constant Course (CRS) in Beacon/NavPoint Course View" page 95.

CDI shows valid values only if target and GPS source supply valid data.

CDI value can be calculated in kilometer or nautical miles details see "Figure 45: Mission Mode - CDI, Distance Mode, Definition for Constant Course (CRS) in Beacon/NavPoint Course View" page 95.

With a long push on rotary knob constant course becomes equal to true bearing.

3.8.4 Mission Mode - Menu Structure

BD406 without control head: N/A

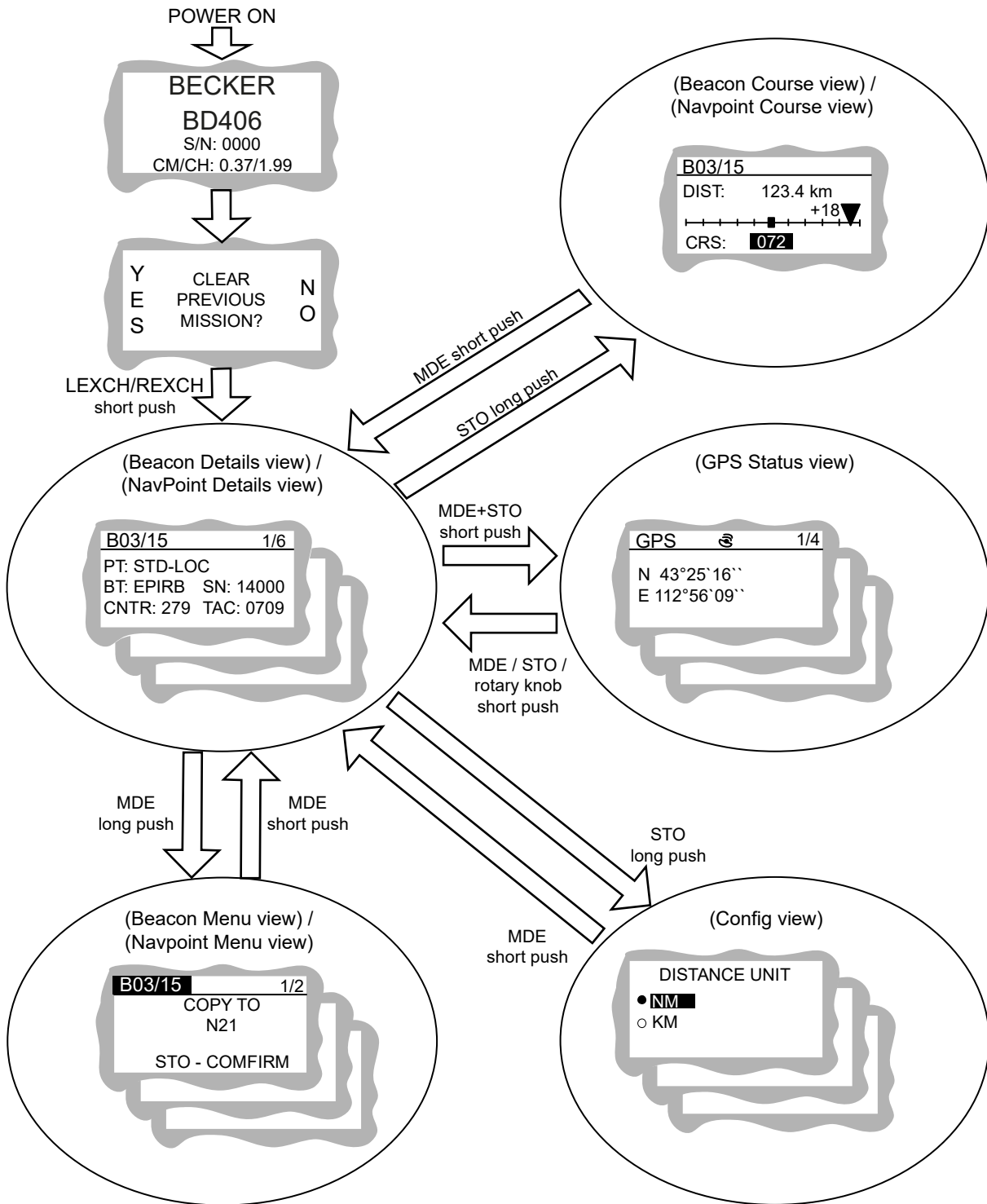
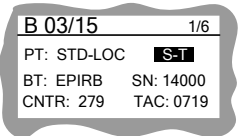

Figure 46: Mission Mode - Menu - Structure

3.8.5 Operations from Beacons/NavPoints Details View

BD406 without control head: N/A

Operation	Description
Left key (LEXCH) short push	Selects the page before with Beacon/NavPoint details (loop function).
Right key (REXCH) short push	Selects next the page with Beacon/NavPoint details (loop function).
MDE key short push	Toggles between Beacon Details and NavPoint Details view.
MDE key long push	Starts Beacon Menu/NavPoint Menu view.
STO key short push	Starts Beacon Course view/NavPoint Course view.
STO key long press	Starts Config view.
Rotary knob left/right turn	Selects the page before/next with Beacon/NavPoint (loop function).
Rotary knob short push	Voice notification homing is generated (depends on configuration).
MDE + STO key push	Starts GPS status mode.

Row ID	Display	Description - Beacon Details View
1		<p>Beacon detailed view:</p> <p>PT: Protocol Type of the received message from selected beacon.</p> <p>STD-LOC: Standard Location Protocol, NAT-LOC: National Location Protocol, USER: User Protocol, USER-LOC: User Location Protocol.</p> <p>S-T flag is visible only if self-test message for related beacon is active.</p> <p>BT: Beacon Type of the received message from selected beacon. Possible designators: EPIRB, PLB, ELT, SSAS, TEST.</p> <p>SN: 5-digit Beacon Serial Number.</p> <p>When unknown protocol is used: ---- is shown.</p> <p>CNTR: 3-digit decimal country code from received message from selected beacon.</p> <p>TAC: 4-digit Type Approval Certificate Number (TAC).</p> <p>If TAC is invalid: ---- is shown.</p> <p>General Notice: Refer to COSPAS/SARSAT documents for definition of protocols, beacon types, TAC. See COSPAS/SARSAT for definition of protocols.</p>

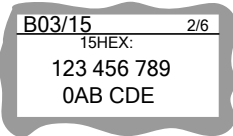
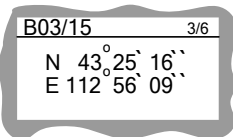
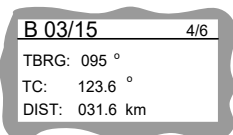
Row ID	Display	Description - Beacon Details View
2		<p>15HexID designator view: 15HEX: 15HexID name with 15 characters string.</p>
3		<p>Beacon position: If position is invalid: - (dash) signs are shown.</p>
4		<p>Bearing, course, distance view: TBRG: 3-digits true bearing (related to the true north). Range 000...359 degrees. TC: 4-digits device true course over ground taken from GPS receiver. Range 000.0...359.9 degrees. DIST: 4-digits device distance to the target. Range 000.0...999.9 distance units (kilometer km or nautical miles NM). If true bearing is invalid: --- is shown. If distance to the target is invalid: ---.- is shown. If true course over ground is invalid: ---.- is shown.</p>

Row ID	Display	Description - Beacon Details View
5		<p>Course deviation indicator view: CDI units, vertical bar range and CDI mode of indications are settable see "Table 11: Mission Mode - Description Config Menu View" page 104. DIST: 4-digits distance to the target. ETA: 6-digits is equal to (ETA + UTC offset) see "Table 11: Mission Mode - Description Config Menu View" page 104. If CDI is invalid arrow and deviation value is not visible. If distance to the target is invalid: ---. is shown. If ETA is invalid or more than 23:59:59: --:--: is shown. Long push to rotary knob: current device position is stored as fixed position. New CDI and navigation values are calculated.</p> <p>a) CDI position (arrow on screen a)) and TO/FROM indicator correspond to the course deviation see "Course Deviation Indicator (CDI) – Beacon/NavPoint detailed Menu" page 94.</p> <p>b) If CDI is out of range – arrow changes its orientation (screen b)) and shows direction of required course correction to eliminate deviation.</p> <p>c), d) CDI in distance mode (km/NM) value ranges [-999...999] of selected units (screens c), d)).</p> <p>e) Number visible near the arrow corresponds to CDI value. For angular CDI value ranges [-90...90] degrees (screen e)).</p>
6		<p>Timestamps for current beacon: Screen shows time markers for currently selected beacon in format: DD – days, HH – hours, MM – minutes, SS – seconds. FT: equal to First Message Detection Time + UTC Offset – time where first signal from the beacon is received. LT: equal to Last Message Detection Time + UTC Offset – last time where beacon was detected. If values are invalid: --:--:--: is shown.</p>

Table 7: Mission Mode - Description Beacon Detail View

Row ID	Display	Description - NavPoint Details View
7		NavPoint identification data view: NAME: NavPoint name. INFO: NavPoint info.
8		NavPoint position: Latitude Longitude If position is invalid: - (dash) signs are shown.
9		Bearing, course, distance view: TBRG: 3-digits true bearing (related to the true north). Range 000...359 degrees. TC: 4-digits device true course over ground taken from GPS receiver. Range 000.0...359.9 degrees. DIST: 4-digits device distance to the target. Range 000.0...999.9 distance units. UU: kilometer km or nautical miles NM. If true bearing is invalid: --- is shown. If distance to the target is invalid: ---.- is shown. If true course over ground is invalid: ---.- is shown.
10		see description row ID 5 from "Table 7: Mission Mode - Description Beacon Detail View" page 99.

Table 8: Mission Mode - Description NavPoint Detail View

Notice: Refer to COSPAS/SARSAT documents for definition of protocols, beacon types, 15HexID, TAC, etc.

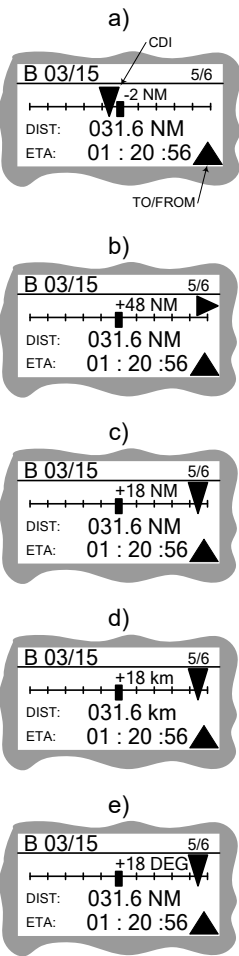
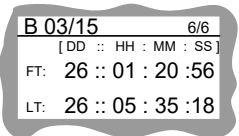
3.8.6 Operations from Beacons/NavPoints Menu View

BD406 without control head: N/A

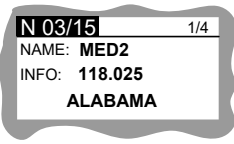
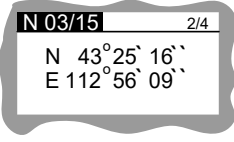
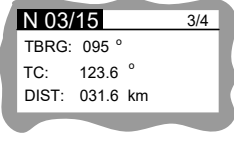
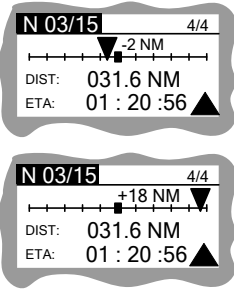
- A long push to MDE key starts this menu.

Operation	Description
Left key (LEXCH) short push	Selects the page before menu action (loop function).
Right key (REXCH) short push	Selects next menu action (loop function).
MDE key short push	Back to Beacon/NavPoint details view.
STO key short push	Accepts entered data and menu operation.
Rotary knob left/right turn	Decreases / increases selected value by one (loop function).
Rotary knob short push	Selects next field (loop function).

Row ID	Display	Description - Beacon Menu View
	 <p>blinks.</p> <p>NO27161 1/5</p> <p>NAME:</p> <p>B2 4</p> <p>STO - CONFIRM</p>	When Beacon/NavPoint menu is active the identification field blinks, characters and background are inverted each 0.5 s.
1	<p>a)</p>  <p>B 03/15 1/2</p> <p>COPY TO N21</p> <p>STO - CONFIRM</p> <p>b)</p>  <p>B 03/15 1/2</p> <p>COPY TO N IS FULL</p> <p>STO - CONFIRM</p>	<p>Beacon edition screen:</p> <p>Copies beacon position to a new NavPoint. Started with long push to MDE key in beacon details view.</p> <p>Push to STO key: beacon position is copied to new NavPoint. Device changes to beacon details view.</p> <p>N: number of first empty record that used to store beacon position. Beacon position is only stored if a free space in memory is available.</p> <p>If NavPoint memory is full (49 NavPoints in nonvolatile memory) screen b) is shown.</p> <p>NavPoint parameters:</p> <p>NavPoint name NXX is equal to BXX (XX is number of the beacon related NavPoint).</p> <p>NavPoint info is equal to beacon 15HexID.</p> <p>NavPoint position is equal to beacon position.</p>
2	 <p>B 03/15 2/2</p> <p>DELETE ALL BEACONS</p> <p>LONG STO - CONFIRM</p>	<p>Deletes all beacons stored in nonvolatile memory.</p> <p>Started with long push to STO key. Device changes to beacon details view.</p>

Table 9: Mission Mode - Description Beacon Menu View



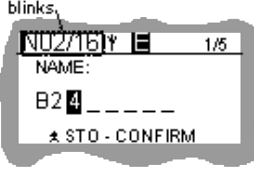
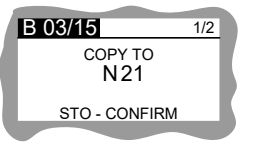
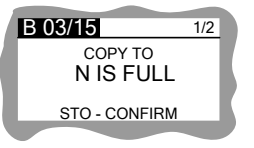
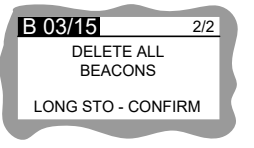

Row ID	Display	Description - NavPoint Menu View
3		<p>Sets name of NavPoint: NAME: field for name.</p> <ul style="list-style-type: none"> All undefined fields for alphanumeric sign are shown as underscore _. Sign is shown only if name is modified but not stored in memory. <ul style="list-style-type: none"> Up to 10 characters. Field can be left blank. These ASCII characters are possible: space, -, ,, /, 0...9, A...Z.
4		<p>Sets info field of NavPoint: INFO: field for info.</p> <ul style="list-style-type: none"> All undefined fields for alphanumeric sign are shown as underscore _. Sign is shown only if name is modified but not stored in memory. <ul style="list-style-type: none"> Up to 20 characters. Field can be left blank. These ASCII characters are possible: space, -, ,, /, 0...9, A...Z.
5		<p>Set NavPoint position:</p> <ul style="list-style-type: none"> Turn rotary knob left/right to change value. Short push accepts character, next field is selected. Sign is shown only if name is modified but not stored in memory. <ul style="list-style-type: none"> Possible values: <ul style="list-style-type: none"> Direction: N/S or E/W DD: 00...89 degree DDD: 00...179 degree MM: 00...59 minutes SS: 00...59 seconds
6	<p>a)</p>  <p>b)</p> 	<p>Set a new NavPoint: Nonvolatile memory for NavPoints is not full see screen a). N: number of the first free record in the memory.</p> <ul style="list-style-type: none"> Short push to STO key to accept setting. Device changes to NavPoint info, see row ID4. When nonvolatile memory is full (49 NavPoints stored) screen b) is shown. STO key is disabled. <p>For new NavPoints:</p> <ul style="list-style-type: none"> If GPS supplies valid data: equal to the current device position. If device position is invalid: equal to N 00O00'00" E 00O00'00". Field name field is empty. Field info is equal to device time + UTC offset and device date + UTC offset.
7		<p>Delete current NavPoint: Long push to STO key deletes NavPoint from memory. Device changes to beacon details view. Screen is only shown if nonvolatile memory is not empty.</p>

Table 10: Mission Mode - Description NavPoints Menu View

3.8.7 Operations from Config Menu View

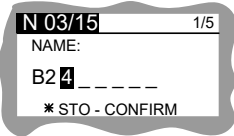
- A long push to STO key starts this menu.

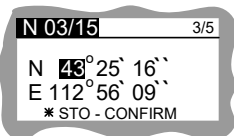
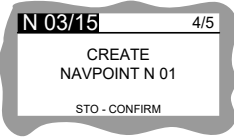
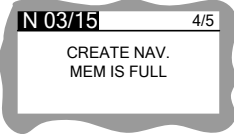
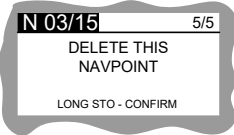
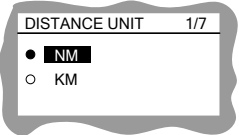
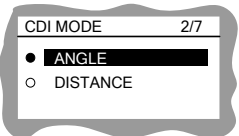
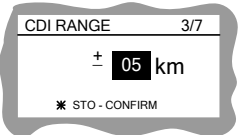
Operation	Description
Left key (LEXCH) short push	Selects the page before (loop function).
Right key (REXCH) short push	Selects next page (loop function).
MDE key short push	Back to Beacon/NavPoint details view.
STO key short push	Context dependent function.
Rotary knob left/right turn	Selects items on the current screen (without loop function).

Row ID	Display	Description - Config Menu View
1		<p>Distance unit setting for all distance indications: Availability of the function depends on configuration.</p> <p>NM: all distances are in nautical miles. KM: all distances are in kilometer.</p> <ul style="list-style-type: none"> • Push to STO key accepts highlighted item.
2		<p>Course Deviation Indicator mode: angular / distance (details "Table 7: Mission Mode - Description Beacon Detail View" page 99, Row ID5).</p> <p>Availability of the function depends on configuration.</p> <p>ANGLE: CDI in degrees. DISTANCE: CDI in distance units (km/NM).</p> <ul style="list-style-type: none"> • Push to STO key accepts highlighted item.
3		<p>Course Deviation Indicator -vertical bar range:</p> <p>XX: range of indicator; changes in range: 5...20 units in 5-unit steps (degree, km, NM). UU: units of the CDI (degree, km, NM).</p> <ul style="list-style-type: none"> • Turn rotary knob to change value. • Push STO key to store. • Sign is shown only if value is modified but not stored in memory.
4		<p>Device action for incoming COPSAS/SARSAT message: Availability of the function depends on configuration.</p> <p>STORE NEW BEACON: when Beacon nonvolatile memory is full new, unregistered incoming beacon message overwrites the beacon with the oldest detection time in database, then warning is shown, details "Warning and Failure Indications" page 86. IGNORE NEW BEACON: when beacon nonvolatile memory is full new, unregistered incoming beacon message is not recorded in database, but warning is shown, details "Warning and Failure Indications" page 86.</p> <ul style="list-style-type: none"> • Push to STO key accepts highlighted item.

Row ID	Display	Description - Config Menu View
5	 <p>The screenshot shows a menu titled 'UTC OFFSET' with a page indicator '5/7'. Below the title, it says '[HH : MM]' and displays '+02:00'. At the bottom, there is a prompt '* STO - CONFIRM'.</p>	<p>UTC offset setting: Availability of the function depends on configuration. HH: hours MM: minutes Range: -12:00 ... +14:00 with 00:15 resolution.</p> <ul style="list-style-type: none"> • Turn rotary knob to change value. • Push STO key to store. • Sign is shown only if value is modified but not stored in memory.
6	 <p>The screenshot shows a menu titled 'POWER SUPP' with a page indicator '6/7'. It displays '12.2 [V]'.</p>	<p>Power supply indicator: Shows power supply voltage with resolution of 0.1 [V].</p>
7	 <p>The screenshot shows a menu titled 'BRIGHTNESS' with a page indicator '7/7'. It displays '75' and a progress bar that is approximately 75% filled.</p>	<p>Backlight brightness regulation: Availability of the function depends on configuration.</p> <ul style="list-style-type: none"> • Brightness range 0...100. <ul style="list-style-type: none"> ○ Progress bar is not filled: brightness value 0. ○ Progress bar is fully filled: brightness value 100. • Turn rotary knob to change value.

Table 11: Mission Mode - Description Config Menu View

3.8.8 Operations from Beacon/NavPoint Course View

- Push to STO key starts this menu.

Operation	Description
MDE key short push	Back to Beacon/NavPoint details view.
Rotary knob left/right turn	Decreases / increases selected value by one (without loop function).
Rotary knob long push	Constant course becomes equal to the true bearing.

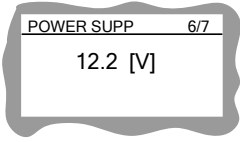
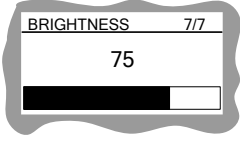
Row ID	Display	Description - Beacon Course View
1	<p>a)</p>  <p>b)</p>  <p>c)</p>  <p>d)</p> 	<p>Course deviation indicator – constant course view (compare with row ID5 "Table 7: Mission Mode - Description Beacon Detail View" page 99).</p> <p>CDI indicator position (screen a)) and TO/FROM indicator related to the course deviation defined in "Figure 44: Mission Mode - CDI, Angular Mode, Definition for Constant Course (CRS) in Beacon/NavPoint Course View" page 95.</p> <p>DIST: distance to the target. YY: current distance units (km/NM). CRS: constant course (1 step resolution). Range [0...359] deg. T: TO/FROM indicator.</p> <p>Number near the arrow related to CDI value. For angular CDI value ranges [-90...90] degrees (screen b)). For CDI in distance mode (km/NM) value ranges [-999...999] of selected units (screens c), d)).</p> <p>CDI units, vertical bar range and CDI mode of indications are settable see "Table 11: Mission Mode - Description Config Menu View" page 104.</p> <p>If CDI is out of range: arrow changes orientation (screen b)) and shows direction of required course correction to eliminate deviation. If any value is invalid: --- is shown. If CDI is invalid: arrow and deviation value is not shown.</p> <ul style="list-style-type: none"> • Turn rotary knob to change constant course. • Long push to rotary knob: Constant Course becomes True Bearing. New CDI and navigation values are calculated.

Table 12: Mission Mode - Description Beacon Course View

Row ID	Display	Description - NavPoint Course View
2		Details see in Row ID1

Table 13: Mission Mode - Description NavPoint Course View

3.9 GPS Status View

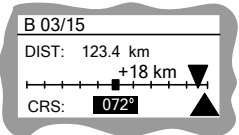
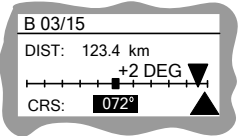
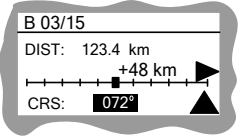
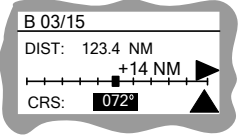
BD406 without control head:

N/A.

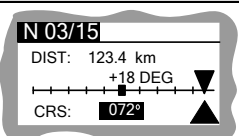
- Push and hold STO and MDE key at the same time starts this menu.

Operation	Description
Left key (LEXCH) short push	Selects the page before (loop function).
Right key (REXCH) short push	Selects next page (loop function).
MDE key short push STO key short push Rotary knob short push	Changes from GPS status view to the last view in mission menu.

Row ID	Display	Description - GPS Status View
1		Device position view: If device position is invalid: - signs are shown.
2		GS: device speed over ground, 4 digits, 0.1 knots resolution TC: device true course over ground, 4 digits, 0.1 degree resolution, range [000.0...359.9] degree. If device speed over ground is invalid: - signs are shown. ALT: device altitude, 5 digits, 1 foot resolution, range [-32000...32000] ft. If device altitude is invalid: - signs are shown.
3		Time stamp – local time: LCL: HH:MM:SS: equal to UTC time + UTC offset. YYYY / MO / DD: equal to UTC date + UTC offset. If any value is invalid: - signs are shown.
4		Positional Dilution Of Precision: PDOP: equal to device PDOP. SAT NUM: equal to number of visible GPS satellites. If any value is invalid: - signs are shown.

Table 14: GPS Status View

3.10 Receive Operation – Message Detection

BD406 is a digital receiver of COSPAS/SARSAT compliant RF signal. It works in a range of 406.020...406.081 MHz.

The receiver continuously scans the rescue band to find beacon transmissions. When it finds a beacon RF signal the full analysis starts to examine the signal amplitude, quality (phase and time parameters), and frequency.



Advanced correction algorithms improve reception ability and supply a wider range in variable environmental conditions. Even if the received signal is distorted due to a beacon malfunction, an excessive distance, or harsh weather conditions, additional actions are started to validate and correct such datagram.

Temperature Compensated VCO guarantees maintenance free, long term stability $\leq \pm 5$ ppm after 10 years at temperature range -40...+85 °C for BD406.

BD406 with control head	BD406 without control head
<p>Usually, when rescue mission is started the beacons database is empty. When device is powered on this screen appears:</p> 	<p>Each restart (power-on/off) of the remote-controlled BD406 results in automatic reset of the beacon database. All received distress messages are erased from memory.</p> <p>The only way to monitor detected messages is to observe transmission at target status output.</p> <p>When the database is empty - an empty basic frame is periodically broadcasted – it is a “keep alive” signal for observers.</p>

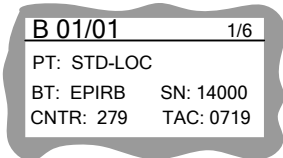
When rescue signal is received - BD406 analyses captured data stream (consisting 112 or 144 bits). It automatically stores decoded data into the first free record of internal beacons database.

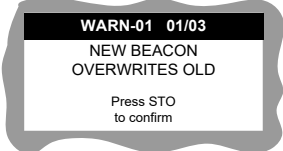
BD406 with control head	BD406 without control head
<p>Voice notification is generated: ‘New Beacon’ and repeated every 6 seconds; a warning message is shown:</p> 	<p>The target status protocol reflects that fact by generating a frame with data corresponding to received data.</p> <p>For next received messages – next frames are visible at target protocol.</p>
<p>The warning message and audio notifications are active until user confirms it with a push to STO key. If warning screen is confirmed beacon detailed view is shown with decoded information about the received message:</p> 	

BD406 with control head	BD406 without control head
<p>When next message from same beacon is received audio notification: 'Beacon' is audible, and the antenna symbol is shown on the screen for 0.5 second.</p>	
<p>When a new message is received the outputs /MSG and /GPO_0 is active for 400 ms. When a message from registered beacon is received again only /MSG is activated for 400 ms.</p>	
<p>The device can store up to 49 different beacons. When beacon database is full, and a received message does not exist in beacon database different warnings can be shown (warning depends on configuration):</p> <div style="display: flex; align-items: center; margin-bottom: 10px;"> <div style="margin-right: 10px;">WARN-01:</div>  </div> <div style="display: flex; align-items: center;"> <div style="margin-right: 10px;">WARN-02:</div>  </div> <p>• Push STO to execute the related action.</p>	<p>It is possible to gather 49 beacons in the database. It corresponds to 49 frames transmitted via target protocol when database is full.</p>

3.11 Contact Data

In case of additional questions contact your local Becker Avionics dealer or forward your request direct to Becker Avionics "Customer Service".

In the event of damage or a defect, the entire device must be returned for repair. The repair must be done by trained Becker Avionics personnel.

For department and addresses, please see contact info page 2.

Any change by the user excludes any liability on our part (excluding the work described in this manual).

Blank Page

Blank Page

4 Index

Abbreviations	8	Spare Parts	31
Accessories	30	Type Plate	36
Airworthiness	27	Units	9
Conditions of Utilization	11	User Interface.....	82
Dimensions	40	Variants Overview	16
Factory Default Settings	67	Warning and Failure Indications ..	97, 101, 103, 105, 106
Installation Requirements	37	Warranty Conditions	11
Non-Warranty Clause	11	Wiring	57
Safety Definitions.....	10		

We reserve the right to make technical changes.
The data match the current status at the time of printing.
© by Becker Avionics GmbH / all rights reserved

***** End of the Document *****